

The Role of Industrial Carbon Capture and Storage in Emissions Mitigation

by

Jessica N. Farrell

B.S. Mathematics

B.S. Applied Physics

Morehead State University, 2016

SUBMITTED TO THE INSTITUTE FOR DATA, SYSTEMS, AND SOCIETY IN PARTIAL
FULFILLMENT OF THE REQUIREMENTS FOR THE DEGREE OF

MASTER OF SCIENCE IN TECHNOLOGY AND POLICY
AT THE
MASSACHUSETTS INSTITUTE OF TECHNOLOGY

JUNE 2018

© 2018 Massachusetts Institute of Technology. All rights reserved.

Signature of Author: _____

Institute for Data, Systems, and Society
May 18, 2018

Certified by: _____

Sergey Paltsev
Deputy Director, MIT Joint Program on the Science and Policy of Global Change
Senior Research Scientist, MIT Joint Program on the Science and Policy of Global Change
Thesis Supervisor

Certified by: _____

Jennifer Morris
Research Scientist, MIT Joint Program on the Science and Policy of Global Change
Thesis Supervisor

Accepted by: _____

Munther Dahleh
W. Coolidge Professor of Computer Science and Electrical Engineering
Director of the Institute for Data, Systems, and Society

The Role of Industrial Carbon Capture and Storage in Emissions Mitigation

by

Jessica N. Farrell

Submitted to the Institute for Data, Systems, and Society
on May 18, 2018 in Partial Fulfillment of the
Requirements for the Degree of Master of Science in
Technology and Policy

ABSTRACT

Carbon capture and storage (CCS) technology holds potential to reduce greenhouse gas emissions from the industrial sector. Industrial CCS applications, however, are more challenging to analyze than CCS in the power sector – mainly due to the vast heterogeneity in industrial and fuel processes. I focus on emission sources from cement and investigate the estimated costs associated with CCS in cement production. These costs are evaluated based on a variety of factors, including the technological maturity of the capture process, the amount of CO₂ captured in different parts of a plant, the percentage of CO₂ captured from the entire plant, and the energy requirements to operate the CCS addition. With the goal of integrating industrial CCS into an energy-economic model, the costs obtained from the literature are used to determine two values: the percent increase in total costs for an industrial plant with CCS and the breakdown of costs into shares of capital, labor, fuel, and other costs. I introduce the industrial CCS options into the MIT Economic Projection and Policy Analysis (EPPA) model, a global energy-economic model that provides a basis for the analysis of long-term growth of the industrial sector, and then I discuss different scenarios for industrial CCS deployment in different parts of the world. I find that in scenarios with stringent climate policy, CCS in the industrial sector is an important mitigation option. Industrial CCS reduces global emissions by an additional 5% by cutting industrial emissions by up to 45%, all while allowing for high levels of industrial production throughout the end of the century. In total, industrial CCS can increase welfare and consumption by up to 70% relative to a global economy under a 2-degree Celsius policy without industrial CCS.

Thesis Supervisor: Sergey Paltsev

Title: Deputy Director, MIT Joint Program on the Science and Policy of Global Change
Senior Research Scientist, MIT Joint Program on the Science and Policy of Global Change

Thesis Supervisor: Jennifer Morris

Title: Research Scientist, MIT Joint Program on the Science and Policy of Global Change

Table of Contents

I.	Introduction	5
II.	Industrial Emissions.....	8
III.	The Cement Industry.....	11
i.	The Cement Manufacturing Process	11
ii.	Cement Production.....	19
IV.	Carbon Capture	22
i.	Post-Combustion Capture	24
ii.	Full and Partial Oxyfuel.....	25
iii.	Other Types of Carbon Capture	26
V.	Literature Review on CCS in Cement Industry	29
i.	Barker et al. (2009)	29
ii.	Hegerland et al. (2006)	36
iii.	NETL (2014).....	39
iv.	IEAGHG (2013).....	41
v.	Cryogenic Carbon Capture	46
vi.	Comparison of CCS Technologies.....	48
VI.	Analysis of CCS Technologies	49
i.	Levelized Cost of Production Methodology	50
ii.	Regional Variation.....	80
iii.	Cement with CCS in Energy-Economic Models.....	83
VII.	Results.....	91
i.	Reference Case.....	91
ii.	Policy without Industrial CCS	94
iii.	Policy with Industrial CCS – Cryogenic Carbon Capture.....	97
iv.	Policy with Industrial CCS – Coal-fired Post Combustion Capture	100
v.	Policy with Industrial CCS – Natural Gas-fired Post Combustion Capture	105
VIII.	Discussion and Sensitivity Analyses.....	109
i.	Sensitivity – Lower Cost of CCS.....	111
ii.	Sensitivity – No Emissions Trading Allowed.....	113
iii.	Sensitivity – Alternative Emission Targets	116
IX.	Conclusion	118
	Appendix A. Fuel Conversion from Biomass and Petroleum Coke to Coal Inputs	121

Appendix B. Mapping of Countries to EPPA regions	123
Bibliography	126

I. Introduction

As global emissions continue to rise around the globe, drastic measures are necessary to reach the 2-degree Celsius (2C) target set by the Paris Climate Agreement. According to the Paris Agreement finalized in 2015, each country was required to submit Nationally Determined Contributions, which represented each country's best effort to reduce greenhouse gas emissions. However, even with all of these contributions, there is a large difference between these pledged reductions and the amounts necessary to limit global warming to below 2C by 2100.

While electricity generation is the primary driver behind global carbon dioxide (CO₂) emissions, a large proportion of emissions are generated from industrial sources, including iron and steel mills, cement plants, and oil refineries. For many industrial processes, CO₂ is generated from both fuel combustion and the industrial process. In 2014, these emissions totaled approximately 8,816 Mt of CO₂, making up approximately 26% of all emissions globally, with the proportion of emissions from industrial sources varying widely by region (IEA, 2015). For example, in China, industrial emissions make up approximately 45% of total emissions, while in the United States, industrial emissions make up 14% of total emissions. By 2050, industrial emissions are expected to grow substantially (IEA, 2015).

Industrial emissions are a persistent source of greenhouse gas emissions that have few alternatives for emission reductions. Efficiency improvements made in a variety of industries have the potential to reduce emissions a certain extent. Another opportunity is industrial Carbon Capture and Storage (CCS), which allows for the removal of approximately 90% of all carbon emissions from the output of an industrial plant. While this technology is immature and currently limited by its costs and increased fuel requirements, it provides a unique opportunity for countries to reduce

their greenhouse gas emissions from the industrial sector when stringent CO₂ emission mitigation is required to reach the goals of the Paris Agreement.

This research accomplishes several things. First, an analysis of the current technological and economic limitations of industrial CCS is conducted, using standardized assumptions to directly compare various CCS technologies. I then add representations of industrial CCS technologies to the MIT Economic Projection and Policy Analysis (EPPA) model, a general equilibrium model that spans 18 different regions and 10 sectors. Next, the potential role of industrial CCS is evaluated using the EPPA model under a variety of policy scenarios, including a scenario without climate policy, a scenario with that seeks to limit the growth in average surface temperature to 2C with a 66% probability, and a scenario limiting global warming to below 2C. Finally, recommendations are made regarding the competitiveness of industrial CCS in a global economy, especially in an emission-constrained system.

In Section II, I discuss industrial and cement emissions and their global contribution to climate change. Section III describes the cement process and cement production. In section IV, I discuss the opportunities for CCS in the industrial sector by overviewing new developments in technology. Section V provides a literature review of four studies that evaluated the cost of CCS technology applied in the cement sector. Section VI details the methodology I created and used to analyze existing options for CCS for cement plants. Section VII provides the results of the economic modeling, including an evaluation of various cement with CCS technologies with and without a carbon policy. Section VIII discusses the results and offers several additional analyses, including with lower technology costs, when prohibiting global emissions trading, and with less stringent emissions targets. Section IX summarizes the results, analyzes the potential for cement with CCS, and overviews the contributions this research has made.

II. Industrial Emissions

Despite improvements in efficiency, total amounts of CO₂ emissions from industrial sources continue to rise. In 2015, total global emissions from all sources of fuel combustion (including electricity) and industry accounted for approximately 35.6 gigaton (Gt) of CO₂, with China, the EU, India, and the United States collectively contributing approximately 21.4 Gt of CO₂. Global emissions from the industrial sector rose from 6.91 Gt of CO₂ in 1990 to 11.1 Gt of CO₂ in 2014, with the increases in emissions in China making up approximately 84% of the global increase in emissions (European Commission, 2017).¹ **Figure 1** shows the industrial emissions by region from 1990 to 2015, obtained from the EDGAR database by the European Commission.

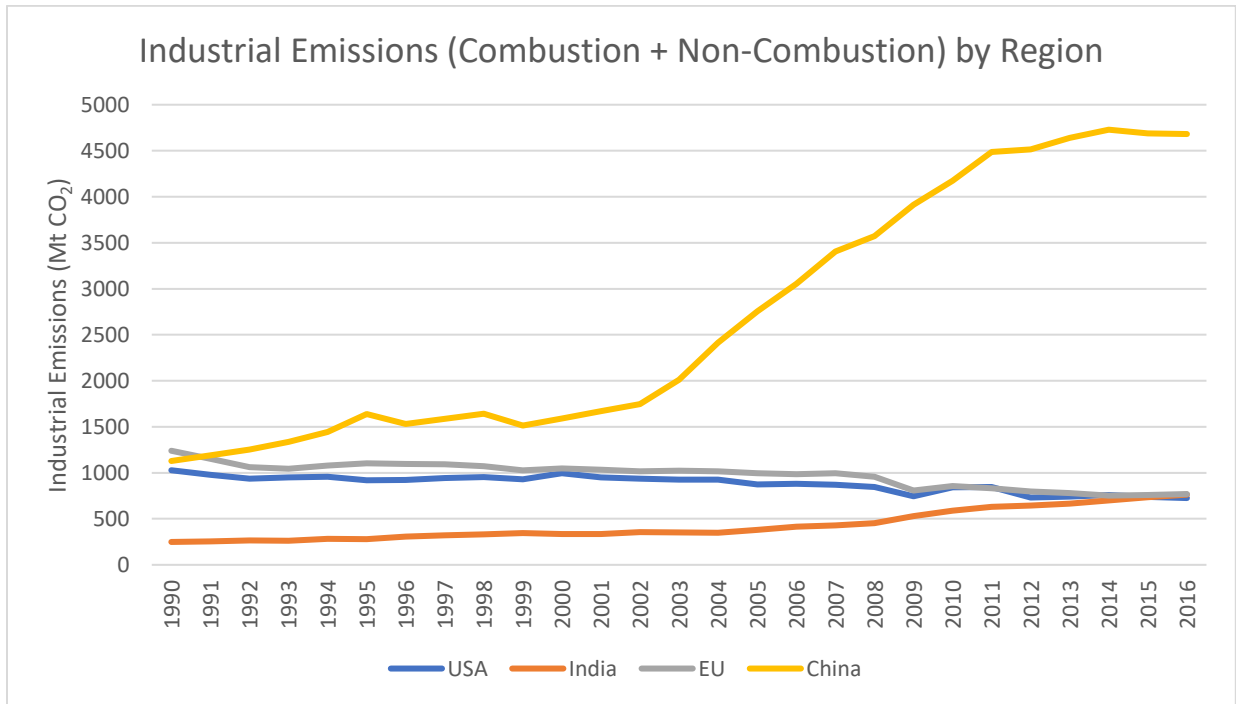

Figure 1. Industrial emissions by region from 1990 to 2015 (European Commission, 2017)

¹ These emissions do not include the indirect CO₂ emissions from the production of electricity and heat obtained from the industry. When included, the global emissions in the industrial sector rose from 10.37 GtCO₂-eq in 1990 to 15.44 GtCO₂-eq in 2010 (Fischedick, et al., 2014).

Emissions from the cement sector are difficult to quantify, as most data is only available for developed countries. Even for China, which is the leading producer of cement, it is difficult to obtain reliable data. The PBL Netherlands Environmental Assessment Agency is one of the few global resources that tracks emissions from the cement industry. In their 2016 report, “Trends in Global CO₂ Emissions,” cement emissions for the largest producers of cement were published. According to their report, China makes up 51.1% of global non-combustion (i.e. process-related) emissions from the cement industry, with India, the European Union, and the United States making up 6.9%, 4.8%, and 2.7% of global emissions, respectively. Non-combustion emissions in China have risen from 0.599 Gt CO₂ in 2010 to 0.733 Gt CO₂ in 2015, rising approximately 4.5% annually. Globally, non-combustion emissions have also risen overall, from 0.51 Gt CO₂ in 1990 to 1.2 Gt CO₂ in 2010 to 1.4 Gt CO₂ in 2015, with cement non-combustion emissions alone making up approximately 4% of global emissions and 13% of all industrial emissions (PBL Netherlands Environmental Assessment Agency, 2017). In total, including both process and combustion emissions, cement-related emissions made up approximately 6.7% of global emissions and 22% of all industrial emissions, with over 2.4 Gt of CO₂ emitted in 2016.²

When compared to other industries, cement remains one of the larger sources of industrial emissions. In the United States, non-combustion cement emissions make up approximately 24.3% of all industrial non-combustion emissions, second only to emissions from the iron and steel industry. In Europe, it makes up 31.6% of all industrial non-combustion emissions, or 8.9% of all industrial emissions. While detailed data is not available for China or India, cement emissions make up a large portion of the non-combustion industrial emissions. **Table 1** shows the breakdown

² In the PBL dataset, only process-related CO₂ emissions were included – to estimate total emissions, it was assumed that process emissions made up 60% of the total cement plant emissions.

in emissions by the cement, iron and steel, and chemicals sectors. Cement produces the majority of emissions in Europe, and the second-largest portion of emissions in the United States. While data in China and India is unavailable, cement produces 48.1% and 47.9%, respectively, of each country’s non-combustion emissions.

Table 1. Non-combustion emissions by the cement, iron and steel, and chemicals sectors (United Nations Framework Convention on Climate Change, 2018)

	China	EU	India	United States
% Non-Combustion Cement Emissions from Industrial Non-Combustion Sources	48.1%	31.6%	47.9%	24.3%
% Non-Combustion Cement Emissions from Industrial Sources	15.6%	8.9%	13.5%	5.3%
% Non-Combustion Iron and Steel Emissions from Industrial Non-Combustion Sources		30.2%		30.5%
% Non-Combustion Iron and Steel Emissions from Industrial Sources		8.6%		6.6%
% Non-Combustion Petrochemical and Ammonia Emissions from Industrial Non-Combustion Sources		18.4%		24.2%
% Non-Combustion Petrochemical and Ammonia Emissions from Industrial Sources		5.2%		5.3%

Because cement has a substantial share of non-combustion emissions, and due to the expected rapid growth in cement production and related emissions, the cement industry is the focus of this thesis. In addition, while there are differences between some cement plants, in comparison to other industrial plants, cement plants are fairly homogenous, with non-combustion and combustion emissions combined in the flue stream. Furthermore, the percent of CO₂ in the flue

stream of a cement plant is greater than the CO₂ concentration of the flue gas of a coal-fired power plant, where CCS has already been explored (Bosoaga, Masek, & Oakey, 2009).

III. The Cement Industry

i. The Cement Manufacturing Process

Cement is manufactured primarily by heating limestone, silicon, clay, sand, iron ore, and shale in a blast furnace. After reaching extremely high temperatures, a hardened substance called clinker is formed from the sintering of the limestone and other materials. Then, the clinker is ground into a fine powder, which is called cement. Often, gypsum is mixed with cement. Then, depending on its end use, cement is then exported to a variety of industries. If cement is mixed with water, it creates concrete.

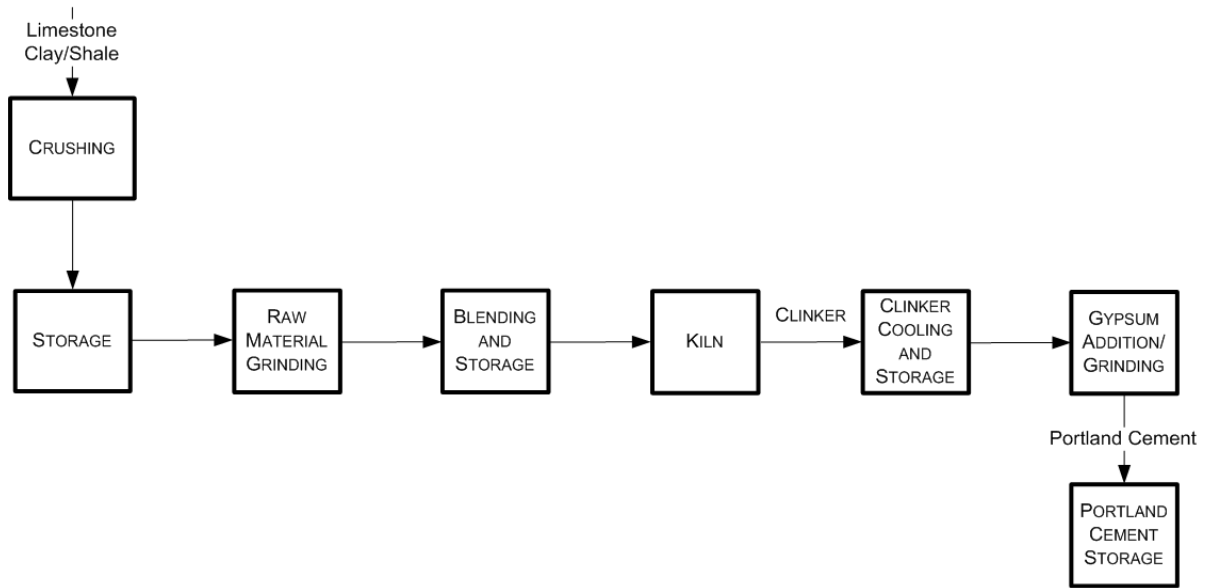

Figure 2. Depiction of the Cement Process (NETL, 2014, p. 93)

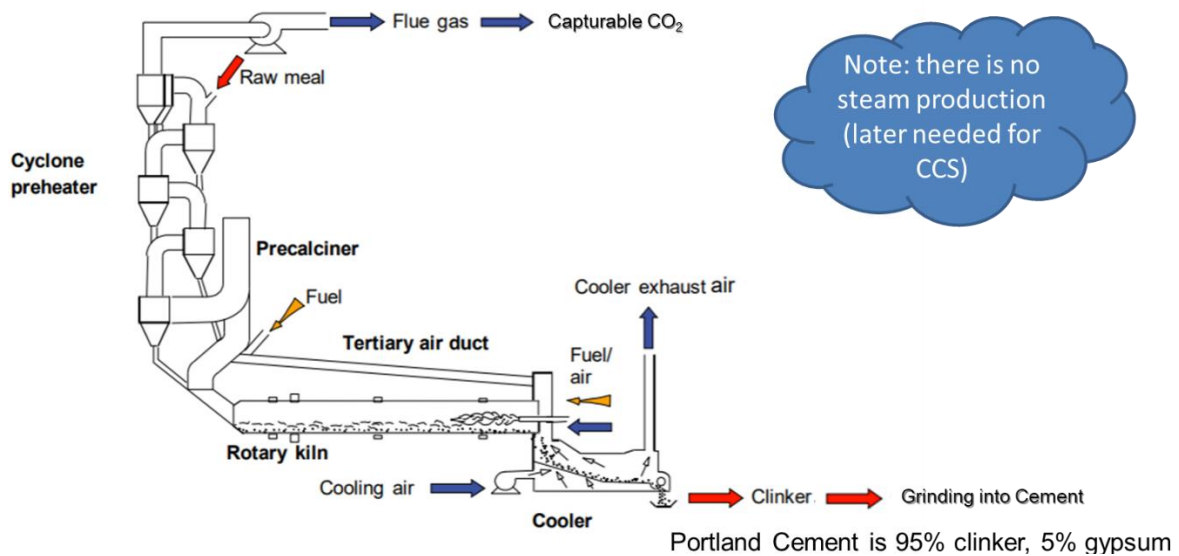

Figure 3. Kiln Process for Cement Production. Adapted from Figure 1-2: Principle of a BAT standard cement plant (IEAGHG, 2013, p. 13)

Figure 2 shows the entire cement production process, while **Figure 3** shows the kiln process in more detail. First, raw materials are extracted from a quarry. The raw materials are chosen based on a combination of five chemical elements and compounds: calcium, iron, silica, alumina, and sulfate. The most common sources of raw materials for cement production are

aragonite, calcite, limestone, marl, shale, clay, iron ore, mill scale, sand, aluminum-ore refuse, fly ash, and gypsum (Portland Cement Association, 2002, p. 25). These materials are then transported, crushed, and milled into a proportion of calcium carbonate (limestone) and silica and alumina (clay, shale, fly ash, slag). This mixing process is either completed using a wet, semi-wet, or dry process.

In a wet process, the fine particles of calcium carbonate and clay are suspended in water. This slurry then flows into the kiln, where the water is evaporated (Moore, Wet and Semi-Wet Process Kilns, 2018a). This process requires a unique kiln, where the thick slurry can be pumped into the rotating kiln. The wet process has a larger heat requirement than the dry process, mainly due to the large amounts of water in the slurry. On average, 5.9 MJ of fuel are needed per kilogram of clinker in a wet process (Hendriks, Worrell, de Jager, Blok, & Riemer, 2004, p. 3). Due to the wet process having a larger heat requirement, the wet process has largely been replaced by a semi-wet or dry process. According to Moore (2018), a semi-wet process “[removes] about two-thirds of the water in the slurry using filters of various sorts, [and] the resulting ‘cake’ could be fed directly to a rotary kiln, or converted wet kiln, or after drying in a preheater, fed to a dry kiln.” A semi-wet process uses approximately 3.6 MJ of fuel per kilogram of clinker. In a dry mixing process, all materials are crushed and grinded into fine particles without water, and then transported into a preheater. A dry mixing process uses approximately 3.2 MJ of fuel per kilogram of clinker.

As shown in **Figure 4**, as of 2006, wet kilns were only used in North America, with the majority of new cement kilns using a dry process, often with pre-heaters and/or pre-calciners. These new, efficient kilns have lower heat demands, which reduces the amount of CO₂ released from fuel use. Approximately “64% of the world’s cement production is delivered by facilities

which are equipped with pre-calciner technology and are [using] state of the art practices (IEAGHG, 2013, p. 7).”

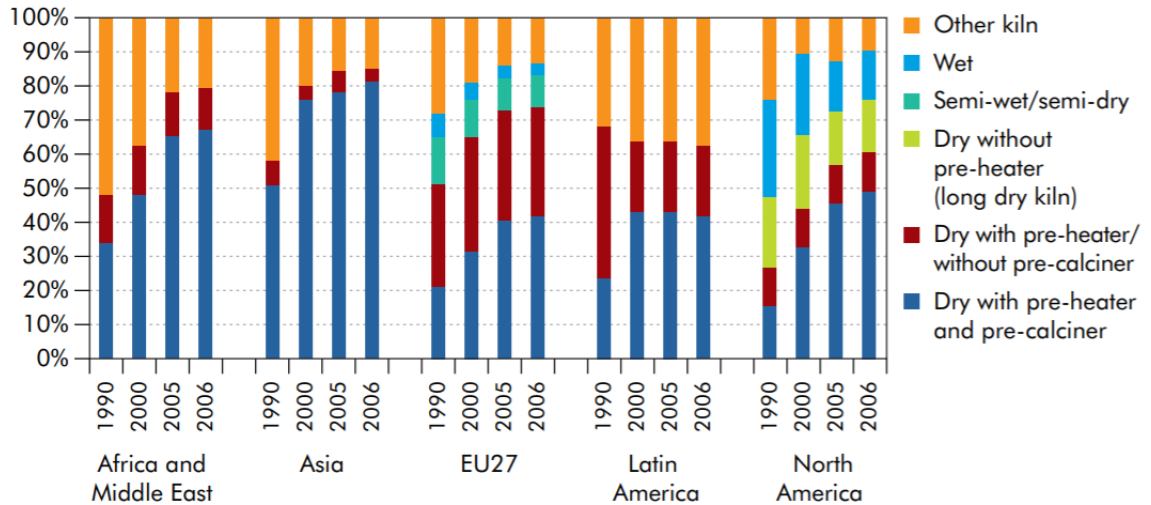

Figure 4. Share of cement kiln technology by region 1990 to 2006. Adapted from Figure 3.1. (IEA, 2009, p. 82)

After the various components are mixed using either a wet, semi-wet, or dry process, the resulting mixture typically passes through a preheater, which is a section of the plant injected with high-temperature kiln exhaust gas, which rapidly heats up the components to approximately 750 degrees Celsius (Moore, Suspension preheater kilns, 2018b). A cyclone then separates the solid and gaseous components. Using the exhaust heat from the kiln, the preheater is able to heat up the materials more efficiently, using less overall fuel. In a pre-calciner, additional fuel is combusted to increase the temperature of the exhaust gases. Approximately 60% of the total fuel consumed during the clinker process is used in the pre-calciner (IEAGHG, 2013, p. 11). The pre-calciner increase the rate of calcination of the raw meal from 5 – 10% (only using a preheater) to 90 – 95%, which increases total clinker output. Using a pre-calciner, the raw mix is nearly calcinated when it enters the rotary kiln. The excess heat from the pre-calciner and preheater is used to dry the meal.

After passing through a preheater and/or pre-calciner, the mix enters the rotary kiln, either in a dry, wet, or semi-wet process. The kiln is fired by combusting coal, oil, natural gas, rubber tires, biomass, and by-product fuel below the kiln and blowing the hot gases and air into the kiln. In this stage, temperatures range between 1400 and 1550 degrees Celsius, and the sintering process takes place. The kiln's construction is often long, cylindrical, rotating, and downward sloping to ensure that the clinker forms uniformly. As the raw materials are fed into the hot kiln, they slowly slide down the kiln, undergoing a chemical reaction to create liquified clinker (Thomas & Jennings, 2008). After passing through the kiln, the clinker is then rapidly cooled using air or water and solidifies. The clinker is then cooled and pulverized. Often, additives are added to produce various qualities within the cement. Gypsum, for example, is added to regulate the setting time of the cement (Thomas & Jennings, 2008, p. 27). Another additive, stearate, can be added to produce water-repellent cements. Other additives promote rapid hardening, used for fast strength development in construction applications. After grinding, the result is an extremely fine gray powder: Portland cement.

The total emissions generated from the cement production process depend on two uses: the process-related emissions resulting from the calcination of the raw meal and the fuel combustion-related emissions generated in the pre-calciner and the kiln. The clinker-cement ratio is one way of measuring the total amount of clinker needed to produce the cement. A low ratio indicates that the cement was formed using less clinker, which inherently emits CO₂ from the calcination process. Various substitutes could be used in place of clinker to produce cement, including fly ash, slag, and limestone, but their applications are extremely limited by their availability (IEAGHG, 2013). Alternatives to cement itself, including Celitement and Novacem, are currently being investigated, but are in early pilot stages with no apparent applicability in the future. Other

potential methods of reducing CO₂ emissions from the cement industry include the applications of alternative raw materials, the utilization of alternative fuels, and increased energy efficiency using pre-calciners.

Table 2 shows the breakdown in emissions per kilogram of cement for a cement plant with varying fuel uses, mixing processes, and clinker – cement ratios (Hendriks, Worrell, de Jager, Blok, & Riemer, 2004). As shown, the dry process emits less CO₂/kg cement, a larger clinker ratio (used for producing Portland cement) increases the CO₂/kg cement ratio, and the carbon content differences in the combustion process lead to varying amounts of CO₂ emissions. The process emissions are located in the second column, and only vary based on the ratio of clinker to cement needed. The emissions relating to fuel combustion are located in the following columns. The fuel combustion values depend both on the mixing type and evaporative heat lost, along with the fuel type itself used.

Table 2. CO₂ emissions per kg of cement produced with varying clinker to cement ratios, mixing processes, and fuels for combustion. Table adapted from Hendriks (2004).

Ratio of Clinker to Cement	Calcination Process Emissions only	Dry Process Combustion Emissions				Wet Process Combustion Emissions			
		Coal	Oil	Natural Gas	Waste	Coal	Oil	Natural Gas	Waste
55%	0.28	0.27	0.22	0.19	0.08	0.39	0.31	0.25	0.08
75%	0.38	0.34	0.28	0.23	0.09	0.50	0.39	0.31	0.09
95% (Portland)	0.49	0.40	0.32	0.26	0.08	0.60	0.46	0.41	0.08

The 2013 IEAGHG report assumes that 60% of the total emissions from a cement plant originate from the calcination process and 40% originate from the combustion process. **Table 3** is a slightly modified version of **Table 2**, with the values shown under the dry and wet process columns being the percent of the total emissions originating from each fuel type. The percent of emissions originating from fuel combustion range from 45 – 58% using coal, 40 – 53%, using oil, 35 – 47% using natural gas, and 14 – 22% using waste products.

Table 3. Percent of the cement total emissions originating from each fuel type.

Ratio of Clinker to Cement	Dry Process Combustion Emissions				Wet Process Combustion Emissions			
	Coal	Oil	Natural Gas	Waste	Coal	Oil	Natural Gas	Waste
55%	49%	44%	40%	22%	58%	53%	47%	22%
75%	47%	42%	38%	19%	57%	51%	45%	19%
95% (Portland)	45%	40%	35%	14%	55%	48%	46%	14%

Primarily due to energy efficiency improvements in cement, the ratio of CO₂ to cement produced has declined globally. The United States still utilizes wet-process cement kilns, which emit greater amounts of CO₂ than dry-process kilns in Asia, Europe, and Africa. **Figure 5** shows the global trend in process-related CO₂ emissions per metric ton.

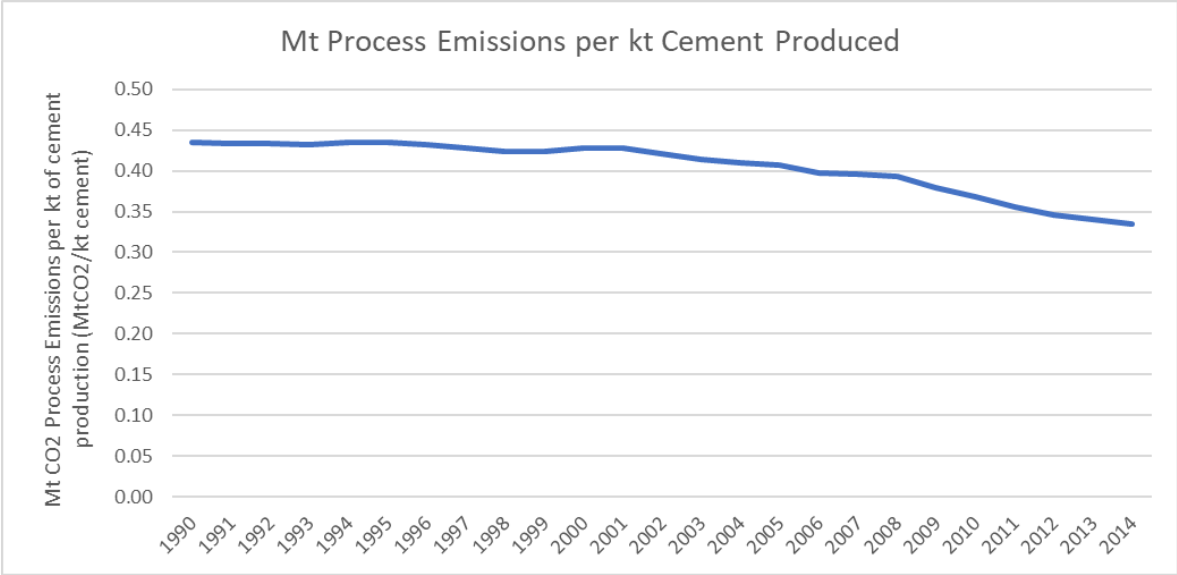

Figure 5. Global Trend in process-related emissions from cement production (United States Geological Survey, 2018); (PBL Netherlands Environmental Assessment Agency, 2017)

ii. *Cement Production*

In 2017, the United States produced 83.5 million metric tons of Portland and masonry cement from 98 cement plants in 34 states, with two additional plants in Puerto Rico (United States Geological Survey, 2018). The overall value of cement sales was approximately \$12.4 billion, with the majority of sales going to produce concrete, with an estimated total value of \$65 billion. Texas, California, Missouri, Florida, and Pennsylvania made up approximately 50% of US production. Between 1998 and 2017, the United States produced over 1.5 billion metric tons of cement. US cement production reached its peak in 2005, when it produced approximately 99.3 million tonnes of Portland and Masonry cement at 115 plants. In 2014, the United States made up approximately 2% of global cement production; China made up approximately 60% of total production. Total global cement production has grown significantly in the past 20 years, from 1.53 billion metric tons in 1998 to 4.17 billion metric tons in 2014. The primary driver of this growth has been Chinese production – in 1998, China produced 536 million metric tons of cement (or 35% of the world’s total production in 1998) and in 2014 China produced 2.49 billion metric tons of cement (or 60% of the world’s total production in 2014). These production levels have primarily been used to fuel the country’s building boom and national investments in infrastructure, and China currently has excess cement production. **Figure 6** shows the cement production by year in China, the European Union, India, and the United States.

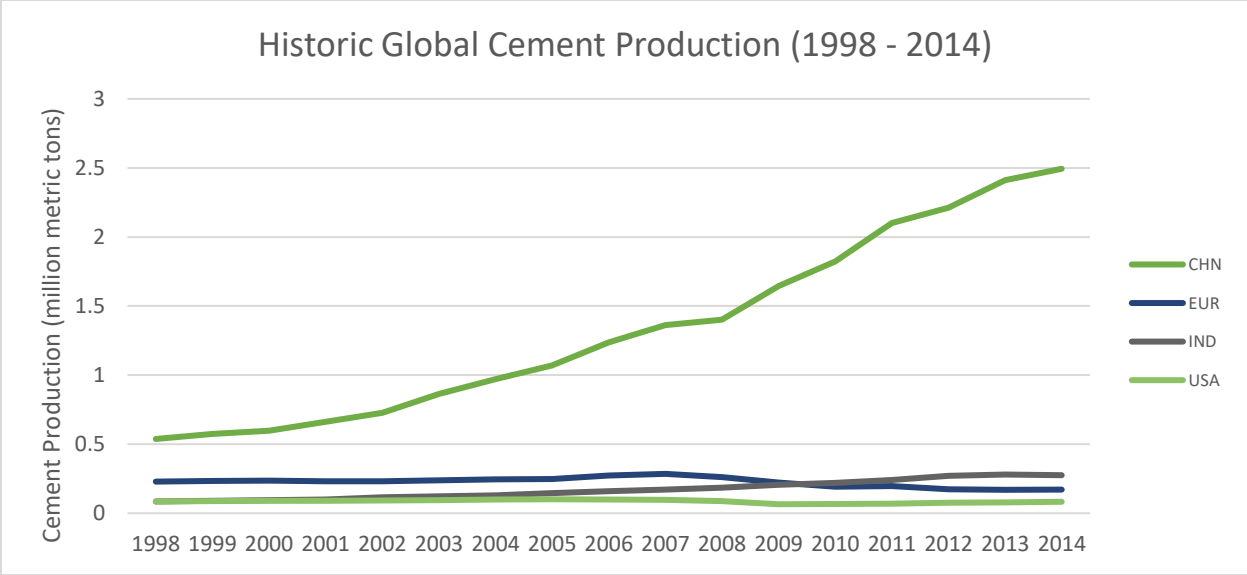

Figure 6. Cement production by year in China, the European Union, India, and the United States. (United States Geological Survey, 2018)

Across the world, cement demand is expected to continue to increase. According to the World Cement Association, 2018 demand for cement is expected to increase 1.5% globally, with markets in France, Germany, Spain, and the United States expecting demand growth of 4%, 5%, 10%, and 6%, respectively (Revill, 2017). According to the IEA (2009), cement demand per capita is expected to stabilize, but with increases in population, the total global demand for cement is expected to increase into 2050. **Figure 7** shows the IEA projections of global cement demand in both low- and high-demand scenarios, along with the estimated global production in 2005 and 2015 (USGS, 2018).

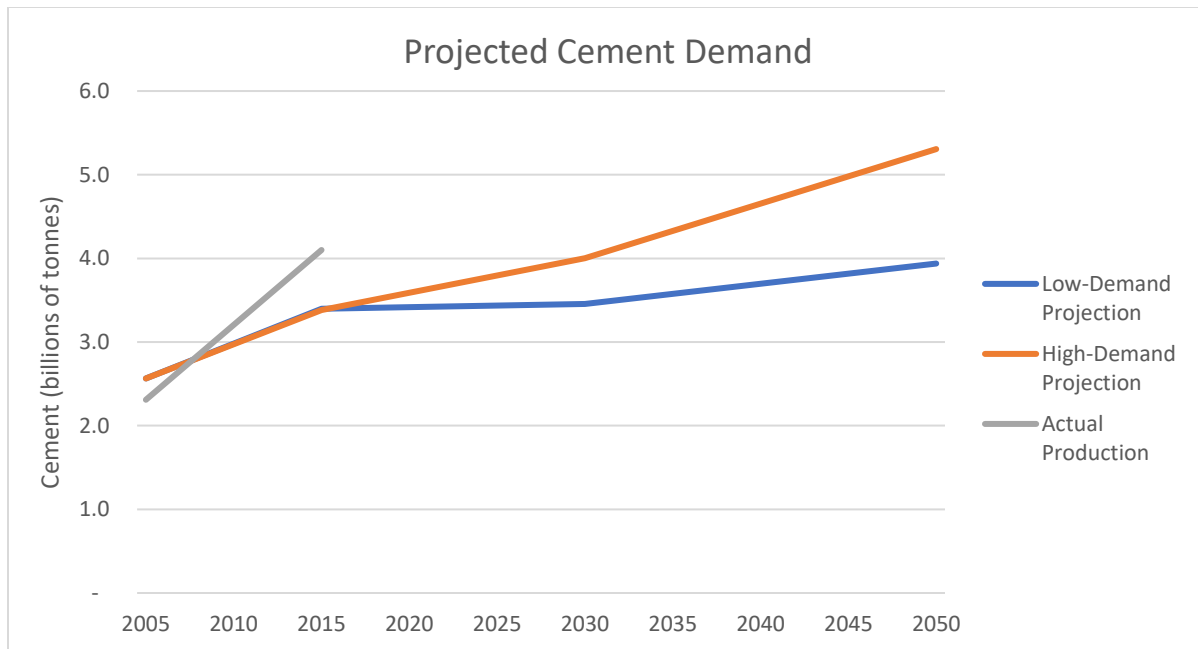

Figure 7. The projected cement demand, based on the 2009 IEA study on industrial demand for cement.³ The actual production data is from the USGS’s global cement production data. (IEA, 2009) (United States Geological Survey, 2018)

The IEA also provides estimates on cement demand in various nations, including the United States, China, and India. Most of the anticipated cement demand is expected in developing regions, including in parts of South Africa, Asia, Latin America, other regions of Africa, the Middle East, regions of Europe, and other Pacific regions.

GDP growth can be a contributing factor to cement demand, along with increased industrialization. In some regions, such as in the United States, GDP has continued to grow while cement consumption has declined since 2006. This is due to both the 2008 financial crisis and the US economy’s increasing reliance on the service sector. In other regions, such as in Saudi Arabia, GDP is positively correlated with cement consumption. In Saudi Arabia, a greater focus of the economy is on infrastructure and oil, which has increased demand for cement production. **Figure**

³ The IEA data obtained was in units of kg/capita. By obtaining projected population estimates from the United Nations Population Division, the total amount of cement demanded was calculated (United Nations, 2017).

8 shows the relationship between GDP per capita and cement consumption in a variety of countries in 2012.

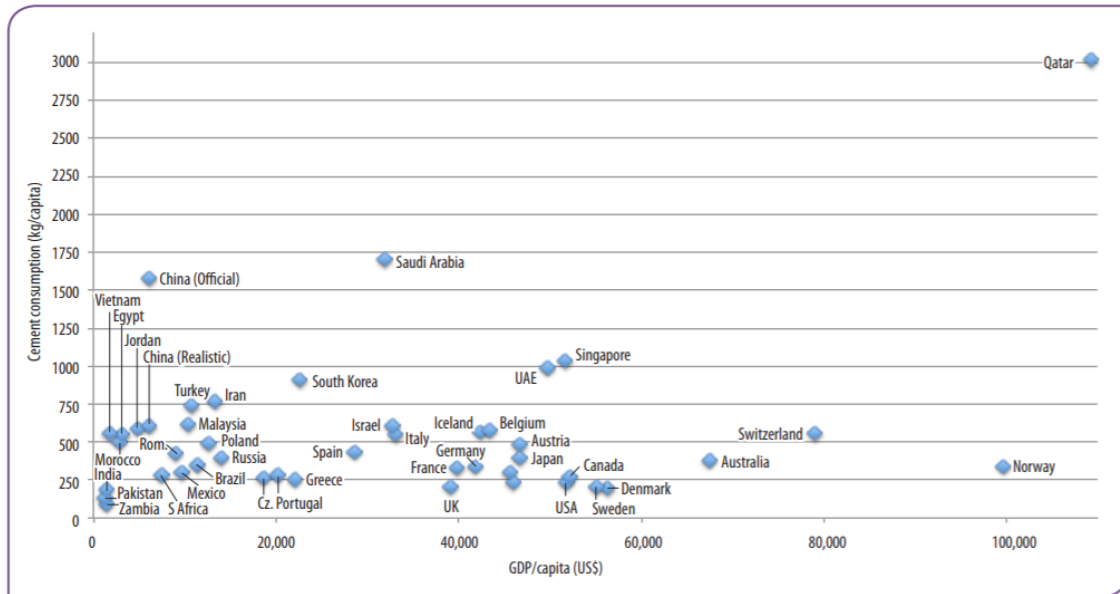

Figure 8. GDP per capita (US\$) and cement consumption (kg/capita) in 2012. (Davidson, 2014)

IV. Carbon Capture

CCS technology has primarily been used to remove CO₂ from the flue stream of coal- or natural gas-fired power plants. CO₂ capture has been used since the 1920s in natural gas reservoirs to separate CO₂ and methane (IEAGHG, 2017). In the 1970s, captured CO₂ began being sold to oil fields in Texas for use in Enhanced Oil Recovery (EOR), where excess oil in abandoned oil wells can be recovered cost-effectively. In the late 1980s and early 1990s, the United States Department of Energy began conducting joint programs with various industries and states in order to demonstrate which “clean coal” technologies were the most promising. Research into CCS technology in the power sector continues today, with major demonstration projects beginning at Boundary Dam and Petra Nova implementing post-combustion amine capture systems.

While the power sector has alternatives to CCS that can also significantly reduce greenhouse gas emissions, there are no alternatives for many industrial processes, including cement, and extensive improvements in energy efficiency have already been made. CCS in the industrial sector allows countries to make large reductions in their industrial sectors while still producing energy-intensive goods, like iron and steel, refined oil, and cement. According to the IEA Technology Roadmap for Carbon Capture and Storage, to limit global warming by 2C, CCS in the iron and steel, cement, and refinery industries must be commercially viable 2025. As seen below in **Figure 9**, according to the IEA’s 2013 report, at least 25% of all generated cement emissions will need to be captured using CCS under a 2C scenario.

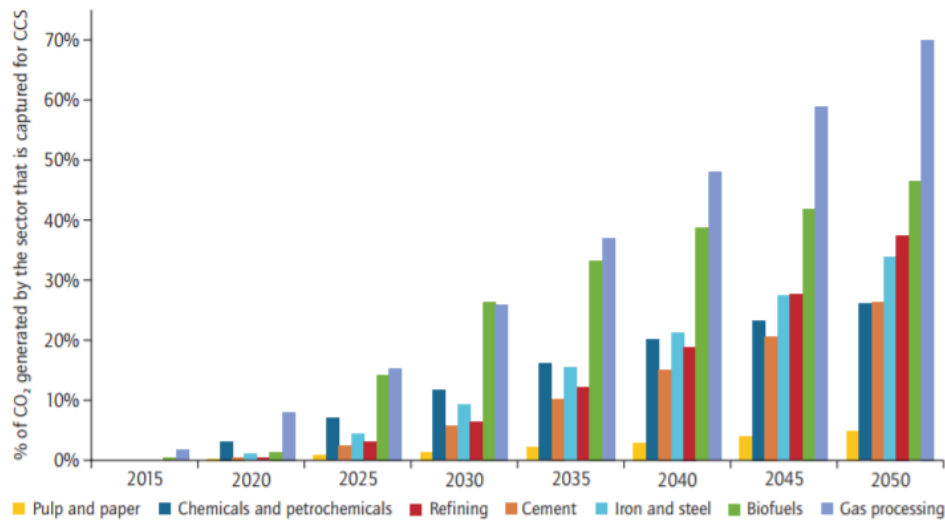

Figure 9. CO₂ captured and stored through CCS in industrial sectors analyzed in the 2DS.
Adapted from Figure 10 (IEA, 2013)

CO₂ is already captured in the oil and gas industry and is occasionally captured from power plants in the food industry. For example, in the natural gas processing industry, the process itself yields a high-CO₂ concentration flue stream. However, many of the larger industries emit flue streams that are similar to flue streams from a coal-fired power plant. These streams are often

contaminated with Nitrogen Oxide (NO_x) and Sulfur Dioxide (SO_x) pollutants, have a low concentration of CO₂, and are released from several locations across a power plant. Therefore, the CCS technologies currently being studied in the power sector have to be modified to work with industrial plants. The following sections outline post-combustion, oxyfuel, and other experimental CCS methods that can be applied to a cement plant. Ongoing cement with CCS research projects are shown in **Table 4**.

Table 4. Pilot and Demonstration Projects Currently Listed by the Global CCS Institute.

Name	Location	Process	Start/End Date	Cost	Sources
CEMCAP	Italy	Oxyfuel and Post-Combustion	2015 – 2018	\$12.1 million	(Global CCS Institute, 2017) (European Commission, 2018)
ITRI Calcium Looping	Taiwan	Calcium Looping	2013 - present	?	(Global CCS Institute, 2018)
Norcem Brevik	Norway	Post-Combustion	2013 - 2017	30% increase	(Global CCS Institute, 2017) (Brevik, 2017)
LEILAC	Belgium	“Direct Separation” – removes CO ₂ from limestone directly	2016 – 2020	\$25.3 million	(Global CCS Institute, 2017) (LEILAC, 2018)

i. Post-Combustion Capture

Post-combustion capture is a technology that captures CO₂ from the end-pipe flue gas of a cement plant. It does so by applying liquid solvents to low-pressure, low-concentration flue gases (NETL, 2018). The acidic CO₂ in the flue gas stream chemically bonds with an alkaline solvent

(such as Monoethanolamine, or MEA) (IEAGHG, 2008). Once the CO₂ is removed from the flue stream, the liquid solution is then heated to release the bonded CO₂. The CO₂ is then cooled and compressed and transported for long-term storage. The heat applied to the solution is also used to regenerate the solvent for future capture. Because post-combustion technology is an “end-of-the-pipe” technology, it is can be retrofitted onto existing plants and does not affect the cement production process itself.

According to the IEAGHG program (2008), post-combustion capture can produce a stream of CO₂ with 99.9% quality. The percent of CO₂ captured from the flue stream is estimated to be between 85% and 90%, but the IEA states that 95% capture can be achieved without significantly affecting the costs of capturing.

However, post-combustion capture has several requirements that can be costly to a traditional cement plant. The solvent is sensitive to impurities typically found in cement flue gas, so extra equipment is needed to remove the concentration of SO_x, NO_x, and dust from the flue gas. The regeneration of the solvent requires large amounts of low-to-intermediate pressure steam (IEAGHG, 2013, p. 12). The waste-heat from a cement plant can only supply 15% of the total heat needed – because of this, either a low-pressure boiler or a combined heat and power (CHP) unit is needed. In addition, the degraded solvent waste needs to be disposed of, which can increase operational costs.

ii. Full and Partial Oxyfuel

Another process that is considered for application in industrial settings is oxyfuel carbon capture. In an integrated oxyfuel process, oxygen is used to fire the pre-calciner and/or rotary kiln instead of ambient air, leading to a purer stream of CO₂ from the combustion process. An air

separation unit is used to separate ambient air into a stream of 95% oxygen, which is then mixed with the recycled flue gas, heated to approximately 800 degrees Celsius via a gas-to-gas heat exchanger and supplied to the pre-calciner and/or rotary kiln. A partial oxy-fuel process uses oxygen only to fire the pre-calciner, while a full oxy-fuel process uses oxygen to fire both the pre-calciner and the rotary kiln. The combustion process yields a stream of 85% vol. CO₂. This stream then passes through a CO₂ purification unit. The heat from the flue gas can be used to produce power, either through an Organic Rankine Cycle or a KA-LINA process. The thermal energy demand is only slightly affected, but there are significant electricity demands from oxyfuel. A full oxyfuel process can capture approximately 85-90% of all CO₂, while a partial oxyfuel process (located only on the pre-calciner) can only capture approximately 60% of the CO₂.

Post-combustion capture is recognized as a more mature technology than oxyfuel, as it has been examined in power plants for several years. In its 2014 report on cement with CCS, IEA estimated that post-combustion capture will not be implemented on a full-scale plant before 2020, and oxyfuel will not be used for a full-size cement plant until 2025.

iii. Other Types of Carbon Capture

Calcium looping is an alternative method of CCS that has the potential to improve energy efficiency and decrease the total amount of CO₂ released from the cement calcination process. Calcium looping reuses deactivated sorbents from post-combustion capture as a raw material in the cement production, which resolves the issues of waste disposal and could reduce overall costs. The CO₂ is captured using several carbonation-calcination cycles and results in a stream of Calcium Oxide (CaO), which can be used as a raw material for clinker production (Romano, et al., 2013). As shown in **Figure 9**, the flue gas from combustion in a coal-fired boiler enters the carbonator, and after exchanging several cycles with the calciner, a stream of CO₂ is outputted for

storage and a stream of CaO is sent to be used for the calcination process in the cement plant. Should the cement plant use only CaO instead of the standard CaCO₃ during the calcination process, the amount of CO₂ released and the amount of thermal energy needed in the kiln will decrease up to 85% and 75%, respectively.

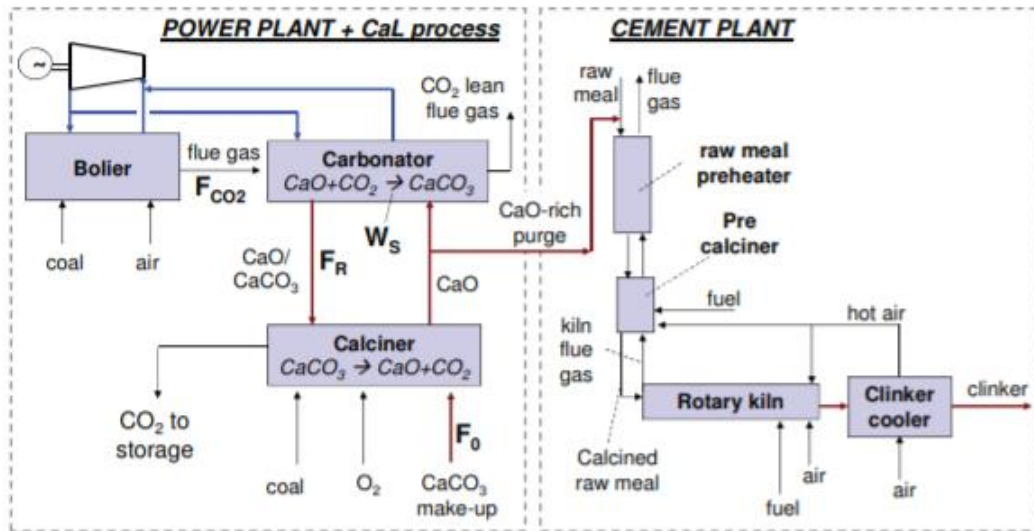

Figure 10.: Layout of the power plant and the cement plant assessed. Adapted from Fig. 1 (Romano, et al., 2013, p. 7193)

The method of chemical absorption is currently used in several industrial sectors and is the most proven technology. In this process, according to the IEA (2014), “aqueous amine solutions are used as absorbents for the CO₂.” While it has been used in industrial settings, it has not been used in cement plants, and is still in early stages of development. In addition, chemical absorption has a high energy demand due to the re-boiling needed for the solvent, and the presence of SO_x and NO_x has a stronger detrimental effect on the chemical absorption process than on the traditional sorbent process. **Figure 11** shows the basic process of absorptive CO₂ capture.

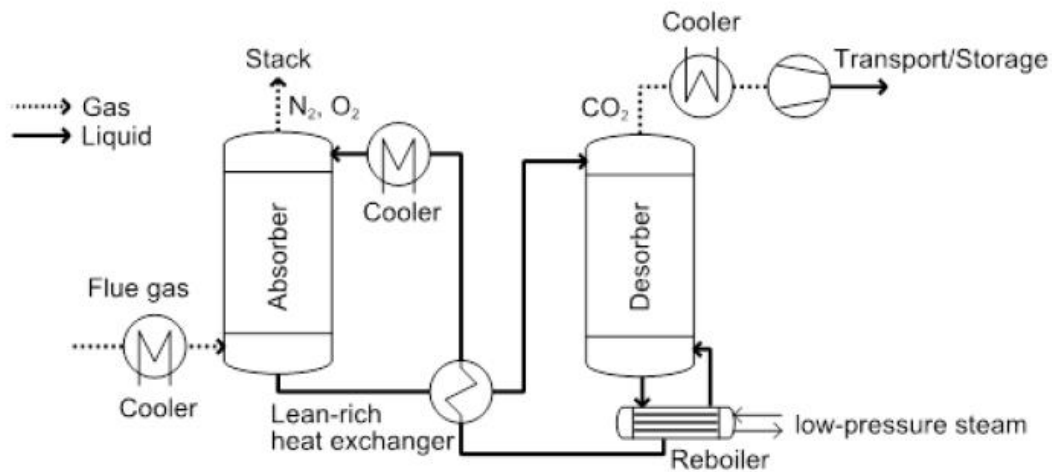

Figure 11. Process of absorptive CO₂ capture (IEAGHG, 2013, p. 47)

Pre-combustion capture is a prominent CCS technology primarily being investigated for application in the power sector. In pre-combustion capture, fuel is reacted with oxygen and steam, which produces both H₂ and CO₂ (IEAGHG, 2008). The H₂ is used as fuel for combustion, and the CO₂ is transported to be stored. While this method has promise in reducing emissions from the combustion process, this method does not offer opportunities to reduce the CO₂ emitted from the limestone calcination process, which is a large portion of the emissions from a cement plant.

V. Literature Review on CCS in Cement Industry

In order to determine the engineering specifications and costs of CCS on cement plants, a literature review was conducted. In total, four different studies were identified that contained sufficient information regarding the inputs and costs of CCS technologies as applied to cement plants. Because there is no operational, large-scale cement with CCS plant in the world, these studies are estimates based on laboratory and pilot-scale tests. Barker et al. (2009) and the IEAGHG (2013) included a reference plant in their engineering and cost analysis, which allows for direct comparison of costs, while NETL (2014) and Hegerland et al. (2006) did not include a reference case. A summary table of the four studies is shown in **Table 5**.

Table 5. Overview of studies for cement CCS.

	Barker	IEAGHG	NETL	Hegerland
Year	2009	2013	2014	2006
Location	Scotland	Europe	Ontario	Norway
Cement Production of Primary Plant (million t/y)	1.0	1.36	0.99	1.4
Study includes Reference Plant?	Yes	Yes	No	No
Type of CCS Studied	Coal PC Oxy-Fuel	Coal PC NG PC Oxy-Fuel	NG PC	Coal PC NG PC

i. *Barker et al. (2009)*

The Barker et al. (2009) study was undertaken by the IEA Greenhouse Gas R&D Programme to assess the technologies available to capture CO₂ from cement plants and evaluate their performance and costs. Barker et al. (2009) studied post-combustion and oxy-combustion CO₂ capture. Pre-combustion capture was not considered, as only the CO₂ from combustion would have been captured, failing to capture the significant amount of emissions from the calcination process. The assessments were based on dry-feed cement plants in northeast Scotland with 5 stages of preheating, producing 1.0 million tonnes cement/year. The capture process was based on existing CO₂ capture technologies and new technologies with moderate risk.

Barker et al. (2009) included a reference cement plant, which included a raw mill, preheater, pre-calciner, fuel prepper, rotary kiln, cooler, and exhaust gas cleaner. **Figure 12** shows the schematic for the reference plant in Barker et al. (2009).

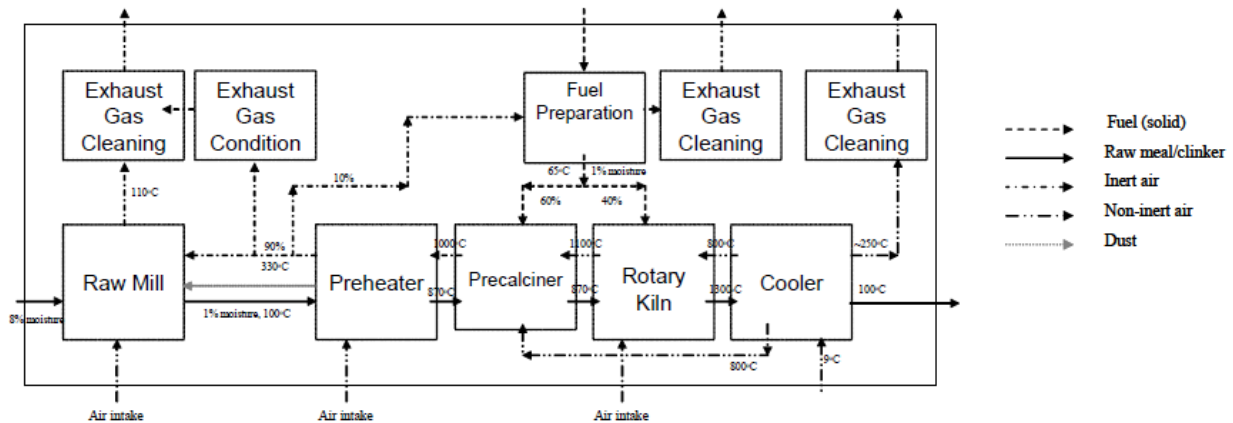

Figure 12. Schematic of a cement plant without CO₂ capture. Adapted from Figure 1. (Barker, Turner, Napier-Moore, Clark, & Davison, 2009).

It is stated that the downstream processes include cement milling, packing, and loading, but it is uncertain whether those processes are included in the cost estimates for a base plant. **Table 6** shows the equipment used for the base cement plant and its total cost. Coal and petroleum coke

are fed into two places into the cement plant – the pre-calciner and the rotary kiln. Barker et al. (2009) does not provide individual equipment cost estimates, but instead provides the total value of equipment in millions of dollars (2013\$) (excluding owner’s costs).

	Reference (millions of 2013\$)
Mill, Silo, Coal Grinding	Included
Storage Raw Material	-
Fuel Preparation	Included
Packaging Plant, conveyor, loading, storing	-
Crushing Plant	-
Preheater	Included
Pre-calciner	Included
Rotary Kiln	Included
Silo	-
Grinding Plant Clinker	-
Exhaust Gas Cleaning	Included
Cooler	Included
TOTAL	\$351.6

Table 6. Equipment used in the reference cement plant.

The post-combustion capture (PCC) case incorporated post-combustion amine scrubbing using monoethanolamine (MEA), which would require limited modifications to the existing cement plant. Barker et al. (2009) considered the following factors:

- The sulfur dioxide (SO_x) concentrations in the flue gas must be limited to 10 ppmv, otherwise the excess will react with acidic compounds to form salts that will not dissociate in the amine stripping system.

- The NO_x concentrations in flue streams vary between 200 and 3000 mg/Nm³, and must be reduced to prevent MEA solvent degradation.
- The quantity of dust must be reduced from approximately 3000 mg/Nm³ to 15 mg/Nm³ via electrostatic precipitators (ESPs) or bag filters, as the dust reduces the efficiency of the absorption process.
- Additional steam is required to power the MEA CO₂ capture, at approximately 3.5 bara and 140-150 degrees Celsius.
- The oxygen concentration needed for absorption must remain above 1.5% (v/v)
- The temperature of the flue gas must be reduced from 110 degrees Celsius to 50 degrees Celsius to reach ideal MEA absorption. This can take place in the Flue Gas Desulphurization (FGD) system
- The presence of hydrochloric acid will reduce the efficiency of the MEA absorption process

In order to address each of these factors, the Barker et al. (2009) study added five features to a regular cement plant. First, an Selective Catalytic Reduction (SCR) unit was fitted between the preheater and the raw mill to reduce the concentration of NO_x. Next, a wet limestone FGD unit was fitted to remove SO_x from the flue gas stream, which will also reduce the temperature of the flue gas stream. A CO₂ capture unit based on MEA amine solvent separation is installed. In addition, a coal-fired combined heat and power (CHP) plant is installed to generate low-pressure steam for MEA stripping and to provide the additional electricity needed for absorption and compression. Using the CHP, there is an excess net amount of electricity generated and then resold to the marketplace. The final CO₂ product is then compressed, dried, and compressed further for

pipeline transportation. Overall, the authors estimated the capture rate for the post combustion CCS unit to be 85%. **Figure 13** shows the schematic for the PCC unit using a coal-fired boiler.

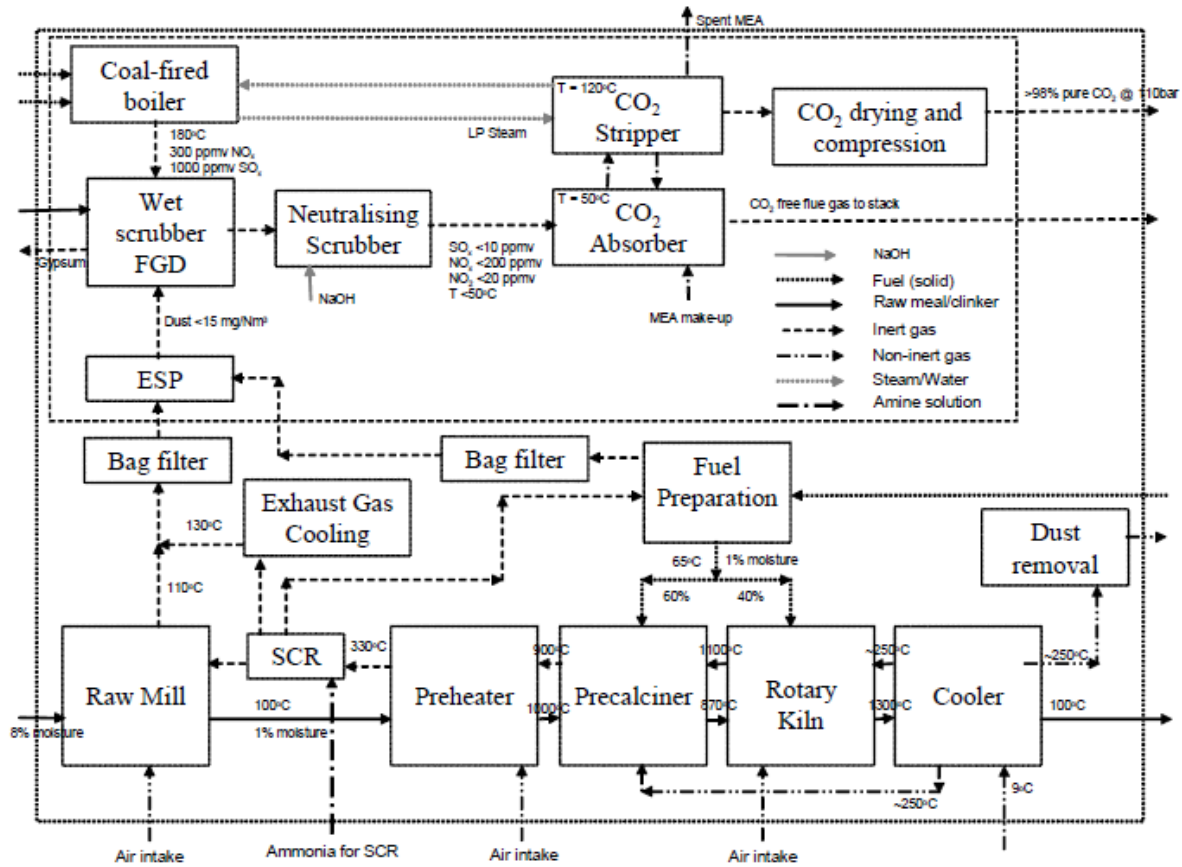

Figure 13. Schematic of cement plant with post-combustion CO₂ capture. Adapted from Figure 2. (Barker, Turner, Napier-Moore, Clark, & Davison, 2009)

Table 7 describes the individual equipment components included in the Barker et al. (2009) coal-fired PCC unit. There is no mention of additional costs relating to duct work, piping, instruments, the site, buildings, or other costs.

Table 7. Equipment used in Barker et al. (2009) coal-fired PCC unit. Barker et al. (2009) does not provide individual equipment cost estimates, but instead provides the total value of equipment in millions of dollars (2013\$) (excluding owner's costs)

	Coal-fired Post Combustion (millions of 2013\$)
Duct Work/Piping	-
SO _x Scrubber	Included
NO _x Scrubber	Included
Boiler (CHP)	Included
CO ₂ Capture	Included
CO ₂ Compressor and Dryer	Included
Electrostatic Precipitator	Included
Instruments, Site, Building, Other	-
TOTAL	\$394.3

The oxy-combustion CO₂ capture case incorporated oxy-combustion of the pre-calciner with air combustion of the kiln. The authors recognized the uncertainties of oxy-combustion, but stated that the uncertainties at the time of writing were not significant enough to make it unfeasible. Barker et al. (2009) notes that it needs to be shown that cement plants can efficiently operate in a CO₂-rich atmosphere and that air leakage can be contained. Barker et al. (2009) considered the following factors for implementation of oxy-combustion:

- The oxy-combustion process depends heavily on the composition of the air inside the combustion chamber, including levels of inert particles and nitrogen
- Due to higher temperatures in the combustion chamber, there will be increased cement kiln wall deterioration
- There may be impacts on clinker production due to the different atmosphere composition
- Air Leaks from the raw mill, preheater, and kiln will dilute the CO₂ exhaust gas
- There may be a need to further remove NO_x and SO_x from the flue gas, along with argon, nitrogen, and water vapor.
- An Air Separation Unit (ASU) is needed to deliver oxygen to the CCS unit, which will require additional electricity

Table 8. Equipment used in the Barker et al. (2009) oxyfuel CCS unit. Barker does not provide individual equipment cost estimates, but instead provides the total value of equipment in millions of dollars (2013\$) (excluding owner's costs)

	Oxy-Fuel
Cooler Modification/ Sealings	Included
Calciner/Preheater Modifications	Included
Rankine Cycle	Included
CO ₂ Processing	Included
Air Separator	Included
Recirculation (Fan, Piping, Heat Exchanger, Condenser)	Included
TOTAL	\$85.5

Overall, the Barker study estimated that the costs to add a coal-fired PCC unit were \$394.3 million, which are greater than the costs of a cement plant alone (\$351.6 million). The equipment costs for an oxy-fired CCS unit were much lower at \$85.5 million, but it should be noted that the capture rate for the oxy-fired unit (62%) is lower than the capture rate for PCC (85%).

ii. Hegerland et al. (2006)

The Hegerland et al. (2006) study was undertaken as a concept study in early 2005 at an existing cement plant in Brevik, Norway owned by Norcem, which is a member of the Heidelberg Cement Group (Hegerland, et al., 2006). The plant is the largest cement plant in Norway at 1.4 million tonnes cement per year. A nearby energy company, Skagerak Energi, sought to build a natural-gas combined cycle power plant nearby with the hopes that the combined captured CO₂ would satisfy the demand for EOR. Hegerland et al. (2006) studied PCC with a boiler using either coal or natural gas. A study of the Norcem plant concluded that amine absorption was the only

viable option for a retrofitted cement plant. The study also included a rebuilding of an off-gas handling system, which could include heat recovery of the off-gases.

The PCC unit incorporated post-combustion amine scrubbing using MEA. Hegerland et al. (2006) acknowledges several factors of the cement plant and capture process that need to be addressed. In order to minimize the amount of NO_x in the off-gas, which would degrade the MEA solvent, Selective Non-Catalytic Reduction (SNCR) was used to reduce the NO₂ content. In order to reduce the content of SO₂ in the off-gas, this study uses sea water scrubbing to reduce the concentration of SO₂ from 200 mg/Nm³ to 2-3 ppm. The dust will be collected using existing ESP and bag filters to reduce the concentration from 40 g/Nm³ to 5 mg/Nm³. Heat recovery and SO₂ scrubbing will sufficiently reduce the temperature for the amine absorption process. Heat recovery will be used to obtain 15% of the steam with the remaining steam being provided from a fired boiler. While the study did not give specific data on the Norcem plant it analyzed, the authors did note that the cement plant currently uses coal to fire its kiln. Overall, the authors estimated the capture rate for the PCC unit to be 85%.

PCC was analyzed using both coal-fired and natural-gas fired boiler. There were several technical differences between the two types of boilers. The coal fuel supply to the cement plant site was already established, while a new natural gas supply would require the construction of a 10-km gas pipeline. A coal-fired boiler would be more expensive to construct than a natural gas-fired boiler, primarily due to the ash and soot formation. SNCR is required for the coal-fired CCS unit, while NO_x burners are sufficient for the natural gas-fired unit. In addition, the electrostatic precipitator and additional filters are needed for the coal-fired boiler and are not necessary for the natural gas-fired boiler. **Figure 15** shows the schematic for the PCC unit using a natural gas-fired boiler.

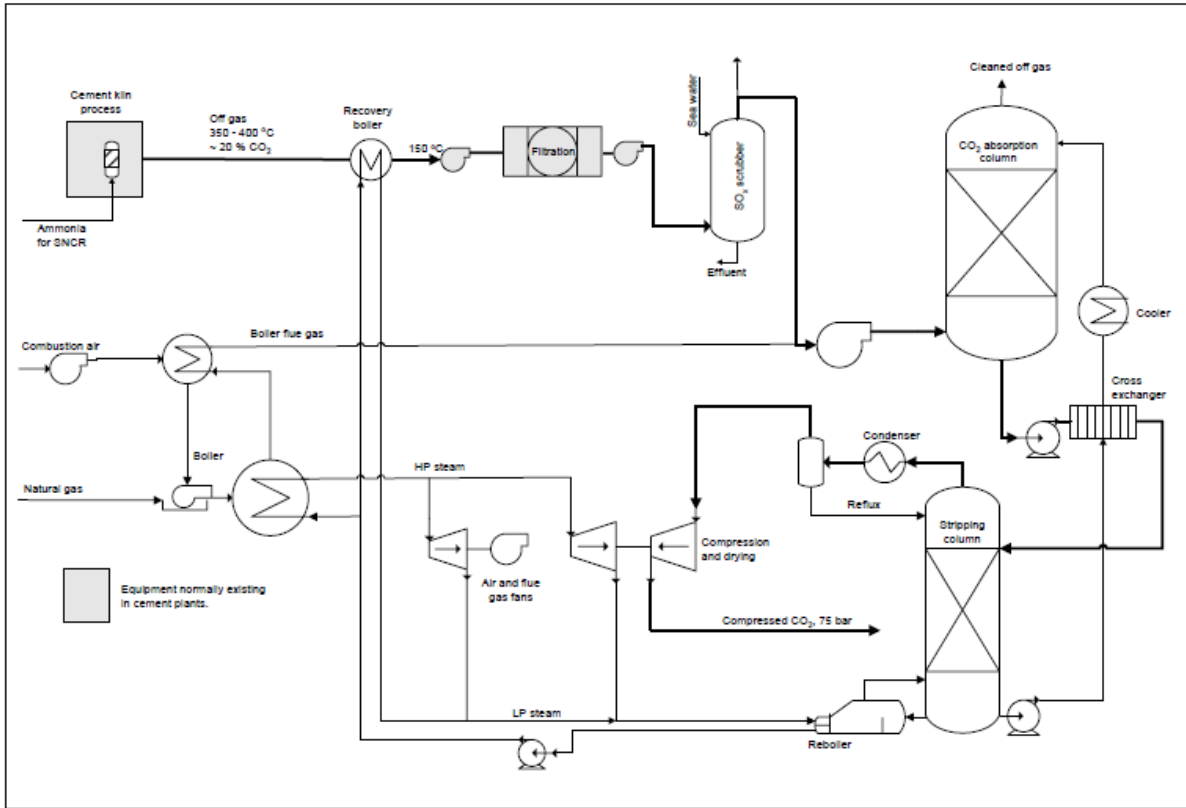

Figure 15. Block diagram for NO_x, SO_x, and CO₂ removal from cement kiln off gases. Natural gas fired boiler for steam generation. Adapted from Figure 1. (Hegerland, et al., 2006)

Table 9 describes the equipment costs in the Hegerland et al. (2006) study for both the coal-fired PCC unit and the natural gas-fired CCS unit.

Table 9. Equipment used in Hegerland et al. (2006) PCC unit with both coal- and natural gas-fired boilers. The value of equipment is listed in millions of dollars (2013\$) (excluding owner's costs)

	Coal-fired (millions of 2013\$)	Natural Gas-fired (millions of 2013\$)
Duct Work/Piping	-	\$3.4
SO _x Scrubber	\$10.7	\$8.5
NO _x Scrubber	-	-
Boiler (Steam Only)	\$25.8	\$13.1
CO ₂ Capture	\$86.9	\$80.6
CO ₂ Compressor and Dryer	\$40.7	\$37.5
Electrostatic Precipitator	\$3.4	-

Instruments, Site, Building, Other	-	-
TOTAL	\$167.5	\$143.6

While the natural gas-fired boiler would require an additional pipeline, the equipment for a natural gas-fired boiler is cheaper than for a coal-fired boiler. Overall, the equipment costs for the coal-fired and natural gas-fired PCC units were \$167.5 million and \$143.6 million, respectively.

iii. NETL (2014)

In 2014, NETL released a report analyzing the costs of capturing CO₂ from a variety of industrial sources, including from cement plants. The cost analysis was based on St. Mary's, an Ontario cement plant that produces 992,500 tonnes cement/year. However, NETL (2014) did not provide cost or engineering details about the St. Mary's plant, so a reference plant was not analyzed.

Because the flue gas from a cement plant requires purification before CO₂ transport, NETL (2014) assumed that a MDEA acid gas removal (AGR) unit would be used, which requires low-pressure steam from a low-pressure natural gas-fired steam boiler. NETL (2014) did not assume that electricity would be generated from this boiler and would instead need to be purchased from the electricity grid. In addition to the steam requirement, NETL (2014) assumed that a cooling water unit was necessary to cool the CO₂ prior to compression and a heat exchanger is needed to cool the CO₂ after compression. While not considered in its base case, NETL (2014) does consider the excess levels of SO_x and NO_x in the kiln off-gas in a separate case. The case includes an FGD system with a gypsum dewatering system to reduce excess SO_x and an SCR system to reduce excess NO_x. The NETL (2014) study also included the costs of duct work and piping, along with

costs relating to instruments, the site, and buildings. **Figure 16** shows the schematic for the NETL (2014) PCC unit, where the kiln off-gas enters the MDEA AGR unit, which yields a stream of water, a vent stream of nitrogen, oxygen, and some CO₂, and a pure stream of CO₂, which is then piped through a heat exchanger, a compressor, and a second heat exchanger.

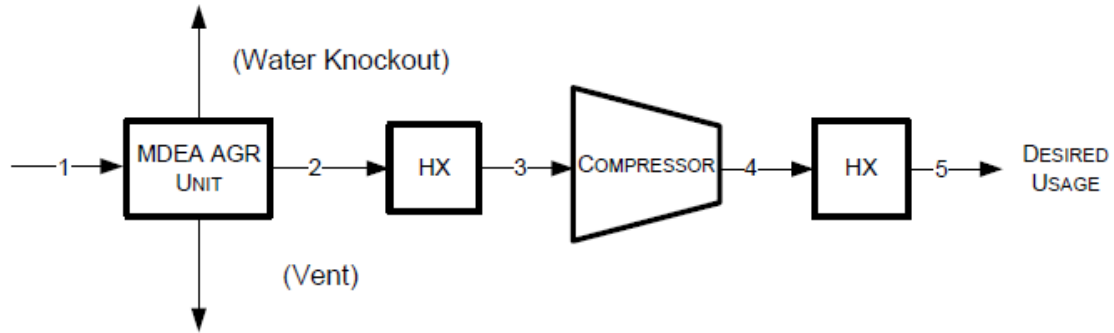

Figure 16. Post-Combustion Capture unit (NETL, 2014, pp. 95-96)

Table 10 lists the equipment costs in the NETL (2014) study using a natural gas-fired boiler for PCC.

Table 10. Equipment used in NETL (2014) PCC unit with natural gas-fired boilers. The value of equipment is listed in millions of dollars (2013\$) (excluding owner's costs)

	NETL
Duct Work/Piping	\$2.5
SO _x Scrubber	\$32.1
NO _x Scrubber	\$7.3
Boiler (Steam Only)	\$6.9
CO ₂ Capture	\$70.9
CO ₂ Compressor and Dryer	\$24.3
Electrostatic Precipitator	-
Instruments, Site, Building, etc.	\$14.4
TOTAL	\$158.2

iv. *IEAGHG (2013)*

In 2013, the IEAGHG (2013) released a report analyzing the costs and engineering details of capturing CO₂ from a cement plant. The cost analysis was based on a conventional green-field cement plant with known technology. IEAGHG (2013) used total plant costs based on the operational costs of European plant.⁴ The equipment used in the reference plant is shown in **Table 11**, with costs in millions of 2013\$. In total, the equipment cost approximately \$92.3 million. These costs are much lower than the equipment costs provided by Barker et al. (2009), who estimated that the total equipment costs are \$351.6 million.

Table 11. Equipment used in the IEAGHG (2013)reference cement plant. The value of equipment is listed in millions of dollars (2013\$) (excluding owner’s costs). (IEAGHG, 2013)

	IEAGHG (millions of 2013\$)
Mill, Silo, Coal Grinding	8.3
Storage Raw Material	4.6
Fuel Preparation	22.2
Packaging Plant, conveyor, loading, storing	8.3
Crushing Plant	4.6
Preheater	15.7
Pre-calciner	
Rotary Kiln	
Silo	15.7
Grinding Plant Clinker	12.9
Exhaust Gas Cleaning	-
Cooler	-
TOTAL	\$92.3

The IEAGHG (2013) study considered four different technologies for CCS: coal-PCC, natural gas-fired PCC, full oxyfuel, and partial oxyfuel.

⁴ The IEAGHG (2013) study cites a 2008 McKinsey & Company, which also evaluated the costs of cement production in the Middle East and China.

First, IEAGHG (2013) considered amine scrubbing PCC using MEA, where they identified that the concentrations of SO₂ and NO₂ degrade the absorbent and reduce its efficacy. By evaluating German cement kilns, IEAGHG (2013) determined that the concentration of NO_x is evenly distributed at 410 mg/m³, while the emissions of SO₂ are on average lower but have higher variability – the amount of SO₂ emitted from the cement plant depend heavily on the quarry and the type of limestone. In order to treat the flue gas, the study includes an SO₂ scrubber and a SNCR technology, while acknowledging that SCR technologies are being tested in some cement plants.

The IEAGHG (2013) also identified the presence of dust as a factor that could cause degradation of the solvent, and acknowledged that a filter could reduce the dust content below 10 mg/m³. A cooling system would also need to be in place to reduce the temperature of the flue gas to between 40 and 60 degrees Celsius. The study includes the use of a 5-stage waste heat regeneration process from the clinker burning process, the exhaust heat of the cooler, and from the wall losses from the rotary kiln, which in total would make up 15 to 30% of the required heat for the solvent regeneration. The remaining heat would be provided by a medium-sized CHP power plant, which would produce a sufficient amount of low-pressure steam. The CHP plant would generate the electrical energy required by the cement plant and the electricity needed for CO₂ compression, with excess electricity being exported to the grid. The study acknowledges that space is limited in many cement plants, so retrofit projects may be limited by space requirements for the various components need for CCS. **Figure 17** shows the basic process of the IEAGHG (2013) PCC process.

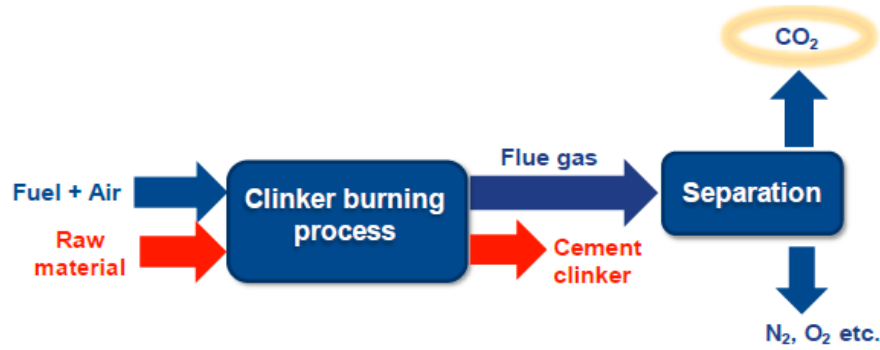

Figure 17. Principle of the post-combustion technology. Adapted from Figure 4-2. (IEAGHG, 2013)

The IEAGHG (2013) study on PCC included the costs of the SO₂ scrubber, a SCR unit to reduce NO_x emissions, the CHP plant, the CO₂ capture and compression unit, and the costs of other components, which are not specified. **Table 12** lists the equipment costs in the IEAGHG (2013) study using both a coal- and natural gas-fired boiler for PCC.

Table 12. Equipment used in the IEAGHG (2013) coal- and natural gas-fired PCC units. The value of equipment is listed in millions of dollars (2013\$) (excluding owner’s costs).

	Coal-fired PCC (millions of 2013\$)	Natural Gas-fired PCC (millions of 2013\$)
Duct Work/Piping	-	-
SO _x Scrubber	\$29.7	\$23.8
NO _x Scrubber	\$6.1	\$6.1
Boiler (Steam Only)	-	-
Boiler (Elec Generation)	\$87.4	\$44.9
CO ₂ Capture		
CO ₂ Compressor and Dryer	\$52.3	\$48.6
Electrostatic Precipitator	-	-
Instruments, Site, Building, Other	\$0.1	\$0.1
TOTAL	\$175.6	\$123.5

IEAGHG (2013) also included both full and partial oxyfuel CCS, viewing them as “promising” technologies for carbon capture in cement plants. In order to implement oxyfuel into

a cement plant, several aspects need to be considered, including the effect on the combustion process, the dilution of the flue gas stream, the lower recirculation rates, the increased complexity of the structure of the cement plant, the modification to the raw material drying process, and the increased sealing needed in the kiln. The implementation of oxyfuel will affect the calcination process by increasing the temperature and pressure. This leads to a higher CO₂ concentration in the circulation process. In addition, the heat capacity of the cooling gas (which impacts clinker production) could be altered by the recarbonation process in full oxyfuel. Again, IEAGHG (2013) highlights issues relating to retrofitting cement plants with oxyfuel, which are primarily based on the space limitations of cement plants. **Figure 18** shows IEAGHG (2013) basic schematic of the full oxyfuel process.

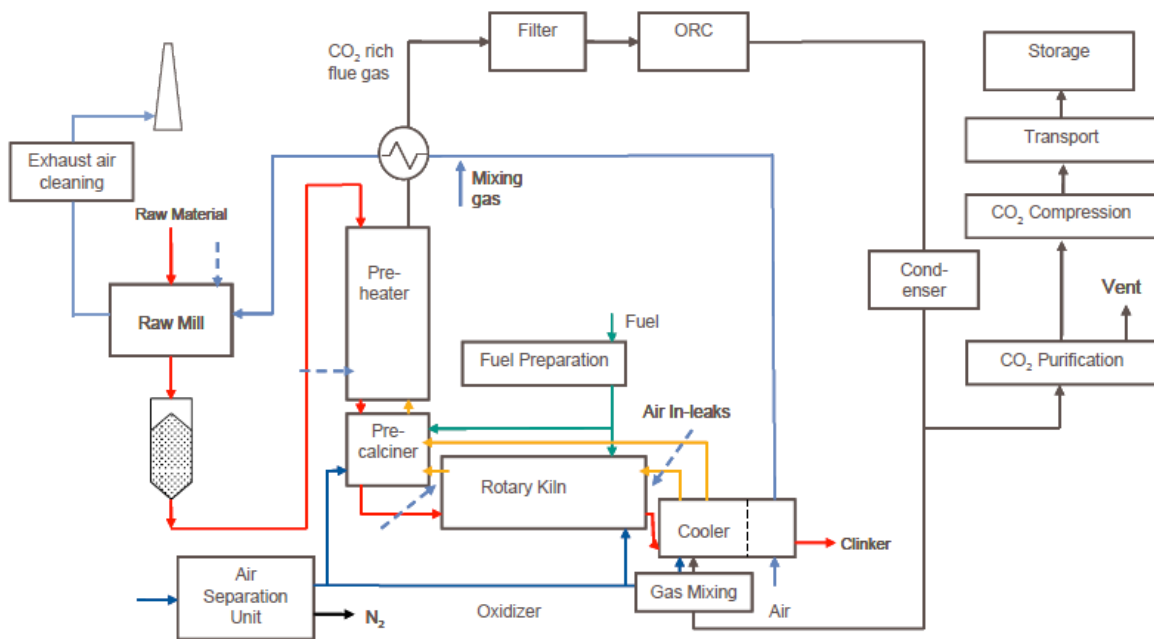

Figure 18. Configuration of a full oxyfuel cement plant [ECR-09]. Adapted from Figure 4-7. (IEAGHG, 2013).

In addition to a full oxyfuel process, IEAGHG (2013) also evaluated the costs of a partial oxyfuel process. **Figure 19** shows the IEAGHG (2013) schematic of a partial oxyfuel process.

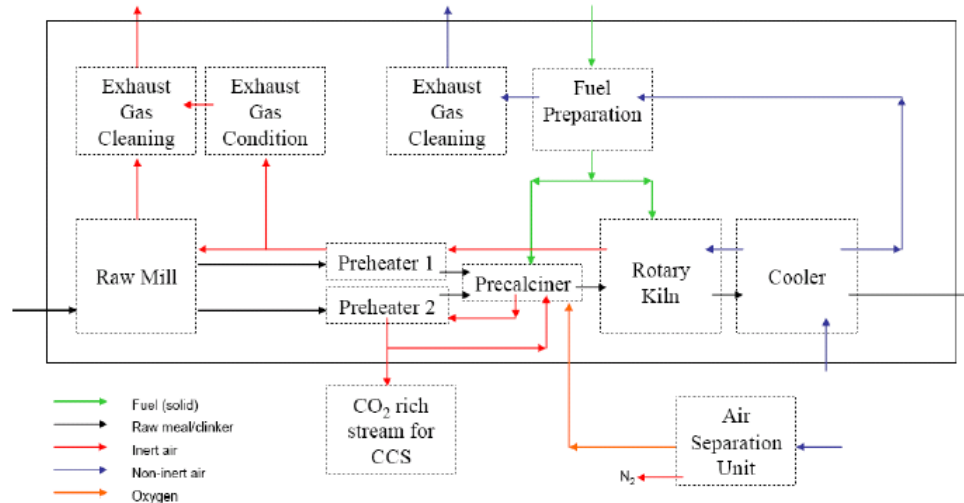

Figure 19. Configuration of a partial oxyfuel cement plant [IEA-08]. Adapted from Figure 4-8. (IEAGHG, 2013).

Additional equipment needed for an oxyfuel unit includes an air separation unit (ASU), a flue gas conditioning CO₂ processing unit (CPU), a two-stage clinker cooler, an exhaust gas recirculation system, a gas-gas heat exchanger, a condensing unit, and a rotary kiln burner for oxy-combustion. An Organic Rankine Process is included to assist with waste heat recovery of the plant. The study also includes the costs of recirculation, which include costs of piping. The ASU and CPU have large electricity requirements and constitute the majority of the increased electricity demand. **Table 13** lists the equipment costs in the IEAGHG (2013) study using both full and partial oxyfuel capture in millions of 2013\$.

Table 13. Equipment used in the IEAGHG (2013) full and partial oxyfuel carbon capture units. The value of equipment is listed in millions of dollars (2013\$) (excluding owner’s costs).

	Full Oxyfuel (millions of 2013\$)	Partial Oxyfuel (millions of 2013\$)
--	--	---

Cooler Modification/ Sealings	4.0	-
Calciner/Preheater Modifications	-	2.0
Rankine Cycle	11.9	11.0
CO ₂ Processing	12.5	10.0
Air Separator	14.4	11.9
Recirculation (Fan, Piping, Heat Exchanger, Condenser)	4.8	2.4
TOTAL	\$47.5	\$37.2

In the IEAGHG (2013) study, the partial oxyfuel technology had the lowest equipment costs at \$37.2 million, with the equipment for full oxyfuel costing approximately \$47.5 million. The coal- and natural gas-fired PCC units cost significantly more than the oxyfuel technologies, with equipment costs of \$175.6 and \$123.5 million respectively.

v. *Cryogenic Carbon Capture*

Cryogenic Carbon Capture (CCC) is a technology owned by Sustainable Energy Solutions (SES). A post-combustion technology, SES claims that up to 99% of CO₂ can be removed from the flue-stream of a power plant by cooling the CO₂ to -140 degrees Celsius so that it changes phase from a gas to a solid (SES, 2018). The solid CO₂ is then mixed with a variety of liquid hydrocarbons, is pressurized and separated from the liquid solvent, melted into liquid CO₂, and delivered at pipeline pressure. An off-stream of N₂ is also produced. The pollutant streams of SO_x and NO_x are also separated using this method, so the costs of removing these pollutants are included in the capital and operational costs. **Figure 20** the process flow diagram of SES's Cryogenic CO₂ Capture (CCC) process.

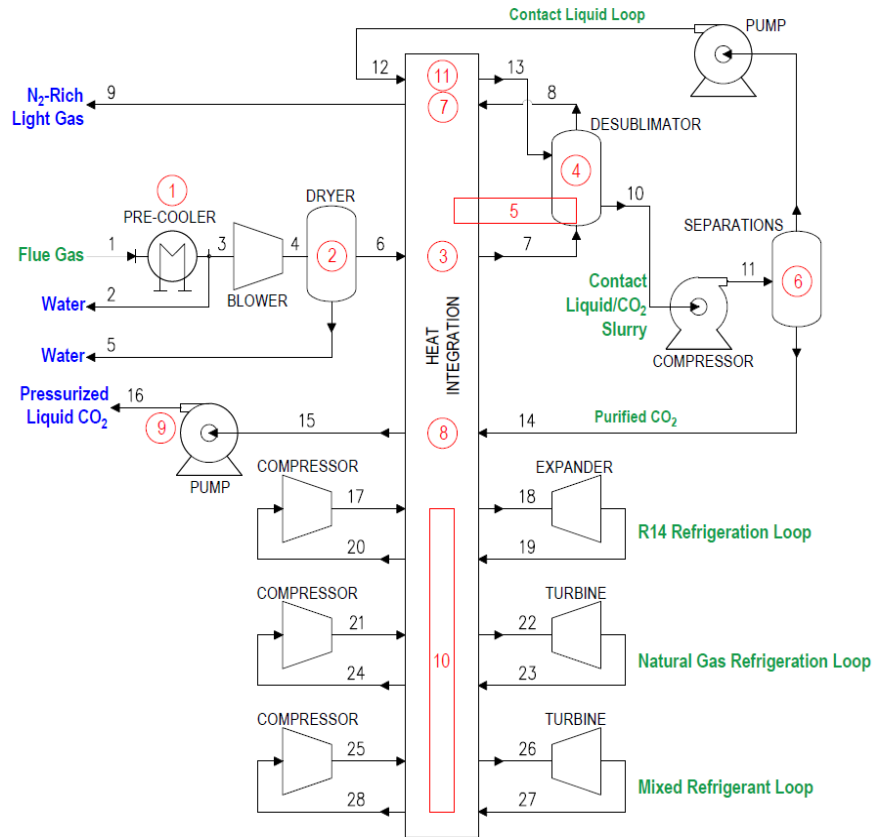

Figure 20. Cryogenic CO₂ Capture (CCC) Process (SES, 2018)

This process uses the solidified CO₂ to cool the warm flue gas from the cement plant and the flue gas to melt the CO₂, which improves the energy efficiency of the process. Unlike other PCC technology, CCC requires electricity to power the capture process and not steam. While CCC is similar to oxyfuel in its fuel requirements, CCC does not require air separation units nor a separate compression unit. Instead, the condensed CO₂ is put under high-pressure by an electrical pump. The equipment costs do not include additional costs of ductwork or piping, but are instead represented by the total plant costs (shown in later section).

Table 14. Equipment costs of Cryogenic Carbon Capture.

	Cryogenic Carbon Capture (millions of 2013\$)
Heat Exchangers	-

Refrigerant Compressors	-
Flue Gas Blowers	-
De-sublimating Heat Exchangers	-
CO ₂ Purification Column	-
TOTAL	\$51.4

vi. *Comparison of CCS Technologies*

The lowest equipment costs are associated with oxyfuel technologies, with the lowest equipment costs in the partial oxyfuel case in IEAGHG (2013) and the CCC case. **Table 15** shows the equipment costs per million metric tons of cement production, and **Table 16** shows the equipment costs per metric ton of CO₂ avoided. For the cases that did not provide a reference cement plant, the rate of production from IEAGHG (2013) was assumed.

Table 15. The equipment costs of the various CCS units per Mt of cement production (in 2013\$/metric ton of actual production).

Equipment Costs per Mt Production					
Type	Barker	Hegerland	NETL	IEA	CCC
Reference Plant	352	-	-	85	-
Coal-fired PCC	394	142	-	161	-
Natural Gas-fired PCC	-	122	159	114	-
Oxyfuel (full/partial)	86	-	-	44/34	-
CCC	-	-	-	-	34

Table 16. The equipment costs of the various CCS units per Mt of CO₂ avoided. The amount of CO₂ avoided is the sum of both the indirect and direct emissions from the cement process, the combustion of fuel, and the emissions from the electricity grid (see **Section VI**). The values are in 2013\$ per metric ton of CO₂ avoided.

Equipment Costs per metric ton CO₂ Avoided					
Type	Barker	Hegerland	NETL	IEA	CCC
Coal-fired PCC	730	288	-	298	-
Natural Gas-fired PCC	-	236	262	195	-
Oxyfuel (full/partial)	192	-	-	71/77	-

CCC	-	-	-	-	79
-----	---	---	---	---	----

One large portion of the equipment costs for many of these CCS units is the cost of either a low-pressure steam boiler or a high-pressure steam boiler with a turbine. As discussed, it is possible to generate electricity from the high-pressure steam needed to capture the CO₂. As shown in **Table 17**, the costs for a low-pressure natural gas-fired steam boiler were estimated to be approximately \$6.9 million in NETL (2014) and \$13.1 million in Hegerland et al. (2006), and Hegerland et al. (2006) estimated the cost for a low-pressure coal-fired steam boiler to be approximately \$25.8 million. Barker et al. (2009) did not provide disaggregated equipment costs, but the costs for a high-pressure steam boiler are estimated to be \$44.9 million for coal-firing and \$87.4 million for gas-firing. This additional piece of equipment can significantly add to equipment costs, but the electricity generated could be resold to generate revenue. Because CCC does not have a steam requirement, the equipment costs are much lower.

Table 17. Steam boiler and turbine information and costs.

		Barker	IEAGHG	NETL	Hegerland
Boiler (low-pressure steam)				✓	✓
Boiler (high-pressure steam + electricity)		✓	✓		
Equipment Costs	Natural Gas	-	\$44.9 million	\$6.9 million	\$13.1 million
	Coal	Unknown	\$87.4 million	-	\$25.8 million
Annual Electricity Generated	Natural Gas	-	693 GWh		
	Coal	103 GWh	219 GWh		

VI. Analysis of CCS Technologies

i. *Levelized Cost of Production Methodology*

Levelized cost, or the cost per unit of output, is a useful metric for summarizing and comparing the costs of technologies. In order to calculate the levelized cost of cement production (i.e. the cost per tonne of cement produced), I extracted engineering and economic details from each study described in Section V for both the reference plant (if available) and the plant with the CCS unit. Data extracted from the studies include the overnight capital costs, the owner’s costs (if included), the variable O&M costs, the fixed O&M costs, the utilization rate of the cement plant, the fuel inputs of the plant and the CCS unit, the electricity requirements of the plant and the CCS unit, the carbon emissions from the cement calcination process, and the percent of CO₂ captured from the flue stream. Some studies, including Hegerland et al. (2006), did not explicitly list fuel inputs, and estimates based on costs were made. These data were combined with assumptions of construction time, interest rates, project life, fuel prices, and the CO₂ content of fuels. **Table 18** summarizes the various assumptions made throughout the calculations.

Table 18. Summary of assumptions for cost calculations.

Type	Value	Source
Owner’s Costs (if unavailable)	7% of Total Plant Costs	(IEAGHG, 2013)
Construction Time	4 years	Assumption
Interest During Construction	4.0%	Assumption
Interest on Capital	8.5%	Assumption
Capital Recovery Charge Rate	10.6%	Assumption
Project Life	20 years	Assumption
Capital Scaling Factor	1.10	Calculated Below
Coal Fuel Cost (in US) (2013\$)	\$65.69/t	(EIA, 2018) Jan 2018 Appalachian Coal
NG Fuel Cost (in US) (2013\$)	\$0.13/Sm ³	(EIA, 2018) Jan 2018, Spot Price
Electricity Cost (in US) (2013\$)	\$89.70/MWh	GTAP Data
Coal Carbon Content	2.720 tCO ₂ /t coal	Industrial Coal (EPA, 2014)
NG Carbon Content	0.002 tCO ₂ /Sm ³	Natural Gas (EPA, 2014)

Electricity Carbon Content	0.490 tCO ₂ /MWh	2015 Emission Rate of US Electricity Grid (DOE, 2016)
CO ₂ Transportation and Storage Costs	\$10/tCO ₂	Assumption from IEA (IEA, 2006)

The costs and inputs for each of these studies were inputted into a standardized Excel spreadsheet in order to calculate the levelized cost of production of cement plants with CCS. **Table 19** shows the engineering and cost data from the Barker et al. (2009) and IEAGHG (2013) studies, which both included a reference cement plant without CCS.

Table 19. Costs of cement production with and without CCS, using engineering and cost data from Barker et al. (2009) and IEAGHG (2013). Blue rows sum to the total cost of production, while orange rows are direct inputs from the studies.

		Unit s	Reference Plant (Barker)	Cement w/ Coal CCS (Barker)	Cement w/ Oxy CCS (Barker)	Reference Plant (IEA)	Cement w/ Coal CCS (IEA)	Cement w/ NG CCS (IEA)	Cement w/ Oxyfuel (IEA)	Cement w/ Partial Oxyfuel (IEA)
[1]	"Overnight" Capital Cost	\$/tonne	340	722	423	177	493	400	262	248
[2]	Total Capital Requirement	\$/tonne	395	837	491	205	572	464	304	287
[3]	Capital Recovery Charge Rate	%	10.57%	10.57%	10.57%	10.57%	10.57%	10.57%	10.57%	10.57%
[4]	Fixed O&M	\$/tonne	24.7	45.7	29.5	19	30.4	22.2	24	23.8
[5]	Variable O&M	\$/tonne	8.7677	15.2357	9.1989	7.4269	15.9875	15.4029	7.3946	7.3799
[6]	Project Life	years	20	20	20	20	20	20	20	20
[7]	Capacity Factor	%	90%	90%	90%	80%	80%	80%	80%	80%
[8]	Maximum Cement Production	tonnes cement/year	1,111,111	1,111,111	1,111,111	1,360,000	1,360,000	1,360,000	1,360,000	1,360,000
[9]	Actual Cement Production	tonnes cement/year	1,000,000	1,000,000	1,000,000	1,088,000	1,088,000	1,088,000	1,088,000	1,088,000
[10]	Operating Hours	hours	7884	7884	7884	7008	7008	7008	7008	7008
	Capital Recovery Required	\$/tonne	46.34	98.31	57.61	27.06	75.51	61.28	40.13	37.95
[11]	SCALED Capital Recovery Required	\$/tonne	50.97	108.14	63.37	29.76	83.06	67.41	44.14	41.74
[12]	Fixed O&M Recovery Required	\$/tonne	27.44	50.78	32.78	23.75	38.00	27.75	30.00	29.75
[13]	Total Coal Input/year	t/year	100,857	329,157	103,036	91,317	399,666	91,317	91,317	91,317

[14]	Coal Input	t coal/t cement	0.10	0.33	0.10	0.08	0.37	0.08	0.08	0.08
[15]	Coal Fuel Cost	\$/t	65.69	65.69	65.69	65.69	65.69	65.69	65.69	65.69
[16]	Coal Total Cost	\$/tonne	6.63	21.62	6.77	5.51	24.13	5.51	5.51	5.51
[17]	Total NG Input/year	Sm ³ /year	0	0	0	0	0	208,713,216	0	0
[18]	NG Input	Sm ³ /t cement	0.00	0.00	0.00	0.00	0.00	191.83	0.00	0.00
[19]	NG Fuel Cost	\$/Sm ³	0.13	0.13	0.13	0.13	0.13	0.13	0.13	0.13
[20]	NG Total Cost	\$/tonne	0.00	0.00	0.00	0.00	0.00	24.94	0.00	0.00
[21]	Total Electricity Input/year	MWh/year	80,417	-22,864	173,448	131,920	-63,051	-483,291	244,309	217,109
[22]	Electricity Input	MWh/t cement	0.08	-0.02	0.17	0.12	-0.06	-0.44	0.22	0.20
[23]	Electricity Cost	\$/MWh	89.7	89.7	89.7	89.7	89.7	89.7	89.7	89.70
[24]	Electricity Total Cost	\$/tonne	7.21	-2.05	15.56	10.88	-5.20	-39.84	20.14	17.90
[25]	Fuel Cost per t Production	\$/tonne	13.83870261	19.57142449	22.32672267	16.38953569	18.93232089	-9.39328473	25.65543027	23.41293027
[26]	Total Cost of Production	\$/tonne	101.02	204.40	132.31	77.33	169.11	110.64	113.38	106.75
[27]	Markup Over Regular Plant		1.00	2.02	1.31	1.00	2.19	1.43	1.47	1.38

Emissions

[28]	CO ₂ Created from Cement	tCO ₂ /year	454,069	360,793	467,642	499,709	499,709	499,709	499,709	499,709
[29]	Carbon Content of Coal	tCO ₂ /tCoal	2.72	2.72	2.72	2.72	2.72	2.72	2.72	2.72
[30]	CO ₂ from Coal	tCO ₂ /year	274,331	895,307	280,258	248,381	1,087,091	248,381	248,381	248,381
[31]	Carbon Content of NG	tCO ₂ /Sm ³	0.0019	0.0019	0.0019	0.0019	0.0019	0.0019	0.0019	0.0019
[32]	CO ₂ from NG	tCO ₂ /year	0	0	0	0	0	396,555	0	0
[33]	Carbon Content of Electricity	tCO ₂ /MWh	0.49	0.49	0.49	0.49	0.49	0.49	0.49	0.49
[34]	CO ₂ from Electricity	tCO ₂ /year	39,404	-11,203	84,990	64,641	-30,895	-236,813	119,711	106,383

[35]	CO ₂ From Fuels + Cement	tCO ₂ /year	728,400	1,256,100	747,900	748,090	1,586,799	1,144,645	748,090	748,090
[36]	CO ₂ From Fuels + Cement + Electricity	tCO ₂ /year	767,804	1,244,897	832,890	812,731	1,555,904	907,833	867,801	854,473
[37]	CO ₂ Emissions per tonne Cement (Direct)	tCO ₂ /tonne cement	0.728	1.256	0.748	0.688	1.458	1.052	0.688	0.688
[38]	CO ₂ Emissions per tonne Cement (Total)	tCO ₂ /tonne cement	0.768	1.245	0.833	0.747	1.430	0.834	0.798	0.785
[39]	Percent CO ₂ Capture	%	0%	85%	62%	0%	90%	90%	90%	65%
[40]	CO ₂ Emissions after Capture (Direct)	tCO ₂ /year	728,400	188,415	284,202	748,090	158,680	114,465	74,809	261,832
[41]	CO ₂ Emissions after Capture (Total)	tCO ₂ /year	767,804	177,212	369,192	812,731	127,785	-122,348	194,520	368,215
[42]	CO ₂ Captured	tCO ₂ /year	0	1,067,685	463,698	0	1,428,119	1,030,181	673,281	486,259
[43]	CO ₂ Avoided (Direct)	tCO ₂ /year	-	539,985	444,198	-	589,410	633,625	673,281	486,259
[44]	CO ₂ Avoided (In-Direct + Direct)	tCO ₂ /year	-	590,593	398,613	-	684,946	935,079	618,210	444,516
[45]	% CO ₂ Avoided (Direct)	%	-	74%	61%	-	79%	85%	90%	65%
[46]	% CO ₂ Avoided (In-Direct + Direct)	%	-	77%	52%	-	84%	115%	76%	55%
[47]	\$/tCO ₂ Avoided (Direct)	\$/tCO ₂ Avoided	-	\$378.54	\$297.87	-	\$312.15	\$189.97	\$183.21	\$238.86
[48]	\$/tCO ₂ Avoided (Total)	\$/tCO ₂ Avoided	-	\$346.10	\$331.94	-	\$268.62	\$128.73	\$199.53	\$261.29
[49]	CO ₂ Transportation Costs	\$/year	\$0	\$10,676,850	\$4,636,980	\$0	\$14,281,195	\$10,301,806	\$6,732,810	\$4,862,585

[50]	CO ₂ Transportation Costs	\$/tonne cement	\$0.00	\$10.68	\$4.64	\$0.00	\$13.13	\$9.47	\$6.19	\$4.47
------	--	--------------------	--------	---------	--------	--------	---------	--------	--------	--------

In order to calculate the levelized cost of production of cement plants, the following calculations were made. First, the total plant costs were extracted from each of the studies. According to Rubin et al. (2013), the overnight costs are the sum of the Base Erected Costs (BEC), the Engineering, Procurement and Construction (EPC) costs, contingencies, the owner's costs,⁵ the equipment costs, and the supporting facilities cost. These costs do not include the interest accrued during construction or the return on capital. The NETL (2014) and Barker et al. (2009) studies provided the owner's costs, while the IEAGHG (2013) study provided a combination of owner's costs and interest accumulated and the Hegerland et al. (2006) study did not provide any estimates of owner's costs. In 2009, the IEAGHG stated that owner's costs can be estimated to be 7% of total plant costs, while the GCCSI estimates that owner's costs are 15% of total plant costs (2011). For both the IEAGHG (2013) and Hegerland et al. (2006) study, owner's costs were estimated to be 7% of the total plant costs. These costs were then divided by the theoretical production capacity of the cement plant [8], yielding overnight costs [1] in terms of \$/tonne cement.

The Total Capital Required (TCR) [2] is the sum of the overnight costs, the interest accrued during construction, and the return on capital required, shown in the equation below.

$$TCR = \text{Overnight Costs} + (\text{Overnight Costs} * \text{Years of Construction} \\ * \text{Interest during Construction})$$

⁵ Owner's costs include pre-paid royalties, land costs, financing costs, inventory capital, pre-production costs, legal fees, and other costs.

To find the TCR for the reference plant in Barker et al. (2009), the overnight costs of \$340/tonne cement were added to the product of the overnight costs, 4 years of construction time, and the 4% interest rate, yielding a value of \$395/tonne cement.

The Capital Charge Rate (CCR) [3] is used to determine the annualized capital cost that must be recovered from cement production (Rubin, 2013). The following equation calculates the CCR.

$$CCR = \frac{\% \text{ Interest on Capital}}{1 - (1 + \% \text{ Interest on Capital})^{\text{Project Life}}}$$

The % interest on capital used is 8.5%, and all projects are assumed to have a financial lifetime of 20 years [6]. Therefore the CCR is a fixed rate of 10.6% for all cement plants.

The fixed O&M costs [4] are obtained from literature. The fixed costs of a cement plant include the annual operating labor costs, the maintenance labor cost, administrative costs, and support labor. In addition, it includes the property taxes and insurance. The total fixed O&M costs are divided by the theoretical production capacity of the cement plant [8]. The variable O&M costs [5] are also obtained directly from literature and include costs related to maintenance material, water treatment, corrosion inhibitors, MDEA solvents, and other consumables needed (including limestone and materials for cement production). The variable O&M costs do not include fuel costs nor costs for electricity. The total variable costs are divided by the actual cement production [9] to yield the variable costs in \$/tonne cement.

As stated above, the estimated financial lifetime [6] of a cement plant is 20 years, which is the amount of time the investor would expect a return on investment. The capacity factor [7], or utilization rate, of a cement plant is how often the cement plant produces cement in a given year.

Barker et al. (2009) (2009) and IEAGHG (2013) assumed a utilization rate of 90%, NETL (2014) listed no explicit utilization rate and was assumed to be 100%, and Hegerland et al. (2006) assumed a utilization rate of 84%. This capacity factor [7] is multiplied by the maximum cement production [8] to determine the actual cement production [9]. The capacity factor [7] is used to calculate the total number of operating hours per year [10].

The Capital Recovery Required (CRR) represents the amount of capital investment in the cement plant per tonne of cement produced, including the capital requirements from interest from construction and the return on capital. The equation below shows the calculation of the CRR:

$$CRR = \frac{TCR * CCR}{Capacity\ Factor}$$

Once the CRR is calculated, in order to find the Scaled CRR [11], the CRR is multiplied by the Capital Scaling Rate. This rate depends on the region, and is discussed further in the section on Regional Variation. In the United States, the capital scaling factor is 1.10, so the CCR is multiplied by 1.10 to obtain the scaled rate.

Similar to the calculation of the CRR, the Fixed O&M Recovery Required is found by dividing the Fixed O&M [4] by the capacity factor [7] to adjust the fixed O&M costs to the actual production levels of the cement plant.

Lines [13] – [25] include the costs of various fuels required for the cement plant and the CCS unit. **Appendix A** overviews the calculations made to approximate coal usage from biomass and petroleum coke inputs. Each study was analyzed to determine its requirements of coal, natural gas, and electricity to power the cement process and the CCS process. Using the assumptions made in **Table 19**, fuel inputs for coal [13], natural gas [17], and electricity [21] were converted to units

of tonnes/year, Sm^3/year , and MWh/year , respectively.⁶ These physical inputs were then divided by the actual production of cement [9] to find the ratio of physical units of coal [14], natural gas [18], and electricity [22] to cement production. Then, these ratios were multiplied by the fuel costs in $\$/\text{tonne}$ coal [15], $\$/\text{Sm}^3$ natural gas [19], and $\$/\text{MWh}$ [23], yielding the total input costs of coal [16], natural gas [20], and electricity [24] in $\$/\text{tonne}$ cement. Each of these is then summed to find the total fuel cost for the cement plant [25].

The total costs of cement production in $\$/\text{tonne}$ of cement produced [26] is found by summing lines [5], [11], [12], and [25], which are the variable O&M costs, scaled capital costs, fixed O&M costs, and the fuel costs, respectively. For cement plants with a CCS unit, the costs of CO_2 transportation and storage [50] are also included in the total costs of production. A markup [27] is then calculated, which is defined as the ratio between the cost of production for a cement plant with CCS relative to the cost of production for the reference plant. For example, in the Barker et al. (2009) study, a coal-fired CCS unit with a cost of production of $\$195.11/\text{tonne}$ cement produced has a markup of 2.07; it is 107% more expensive than the reference cement plant in Barker et al. (2009).

The amount of CO_2 produced from a cement plant originates from two different sources: the calcination process and the combustion process from fuels. None of the studies reported the amount of CO_2 emitted from calcination and from fuels; the studies instead provided the total amount of CO_2 produced from the entire process [35]. In order to use standard emission factors and provide comparisons between technologies, the amount of CO_2 released from calcination was estimated by finding the difference between the total amount of CO_2 released and the amount

⁶ A negative value for electricity usage and costs ([21], [22], [24]) indicate that the plant generated excess electricity and sells this excess generation to the electricity grid.

released from the combustion of fuels. By multiplying the ratio of CO₂ to physical unit for coal [29], natural gas [31], and electricity [33] with the total amount of coal [14], natural gas [18], and electricity [22] used per year, the total amount of CO₂ released from coal [30], natural gas [32], and electricity [34] per year was determined.⁷ The amount of CO₂ created from the calcination process in the cement plant [28] was then calculated by subtracting the total amount of CO₂ from the direct combustion of fuels ([30]+[32]) from the given total amount of CO₂ [35].

While some cement plants generated their own electricity, some plants needed additional electricity from the grid to power both the cement process and the CCS process. In order to account for the CO₂ produced off-site to produce this electricity, the emissions from electricity were calculated [38]. While these emissions are not generated directly at the plant via combustion, should there be a carbon price, it is important to consider all emissions. The total amount of CO₂ both produced and consumed by the cement plant [36] is found by summing [34] and [35]. The carbon intensity of each plant is calculated for both direct emissions [37] and total emissions [38] by dividing the total CO₂ for direct emissions [35] and total emissions [46] by the actual cement production [8].

The rate of carbon capture [39] is obtained from the literature and is defined as the percentage of CO₂ removed from the flue stream of the cement plant. For example, a capture rate of 85% indicates that 85% of the CO₂ in the stream was removed, while 15% was not removed and was released into the atmosphere. The percent capture for the reference plants was 0%. The amount of CO₂ captured from CCS [40] is the product of the amount of direct emissions [35] and the capture rate [39]. The remaining emissions that are expelled to the environment directly from

⁷ In several cases, the CO₂ emissions from electricity are negative. This occurs when the cement + CCS plant produces its own electricity and sells it back to the electricity grid. The negative value is used to credit plants that use additional fuel to generate their own electricity.

the plant [40] are the difference between the total emissions [35] and the captured emissions [42]. If you add the emissions reduced/gained from the electricity produced/purchased [34] to the emissions after capture [40], you obtain both the direct and indirect CO₂ emissions after capture [41].

CO₂ avoided [43] is a calculation used to quantify the impact of a CCS unit on emissions overall. Because a CCS unit requires electricity and steam, there is an increased use of fossil fuels to power the CCS unit. This additional fuel requirement increases the overall amount of CO₂ created from a cement plant. In order to account for this additional CO₂ created, the CO₂ avoided by installing a CCS unit is calculated. The equation below shows the calculation for CO₂ avoided.

$$CO_2 \text{ Avoided} = CO_2 \text{ Emitted from Reference Plant} - CO_2 \text{ Emitted with CCS}$$

For example, the reference plant in Barker et al. (2009) emits approximately 728,400 tCO₂/year [40]. The coal-fired CCS plant in Barker et al. (2009), after 85% capture, emits 188,415 tCO₂/year [40]. Therefore, the direct CO₂ emissions avoided are 539,985 tCO₂/year [43]. The indirect CO₂ emissions avoided [44] are calculated similarly, using both direct emissions and the emissions from electricity. In order to determine the percent of CO₂ avoided [45], the following equation is used:

$$CO_2 \text{ Avoided (\%)} = \frac{CO_2 \text{ Avoided}}{CO_2 \text{ Emitted from Reference Plant}}$$

Therefore, the percent of CO₂ emissions avoided in the Barker et al. (2009) coal-fired CCS unit is 74% [45]. This indicates that the use of a cement with CCS plant would overall reduce emissions by 74% instead of by the amount captured. A similar calculation can be used to determine the total amount of emissions avoided, including electricity [46]. By including the

emissions from electricity into CO₂ avoided calculation, in some studies the percent of emissions avoided increases, while it decreases in others. For plants that primarily rely on purchasing electricity off-site, when you include the emissions generated off-site, the percent amount of emissions avoided will decrease. For those plants that generated their own electricity offsite, the percent avoided increases.⁸

Using the values for the amount of CO₂ avoided, the cost per metric ton of CO₂ avoided [47] can be calculated using the equation below.

$$\text{\$ per tonne of CO}_2\text{ avoided} = \frac{\text{Cost of Production} * \text{Actual Production}}{\text{CO}_2 \text{ Emissions Avoided}}$$

Above, the cost of production per unit of cement [26] is multiplied by the actual production in metric tons of cement [9]. This yields the total cost of the plant, which is then divided by the total CO₂ emissions avoided [43]. A similar calculation was used to determine the cost of avoided CO₂ [48] when accounting for the emissions from electricity. This metric can be used to estimate the competitiveness of industrial CCS given a carbon price. For example, the coal-fired CCS unit in the Barker et al. (2009) study has a \$/tCO₂ avoided (including emissions from electricity) of \$330.36. Coupled with the value of cement sold, should a carbon price approach this total cost, it may be cost-effective to implement this technology.

As a final component of cost, lines [49] and [50] calculate the costs of transporting and storing the captured CO₂. Using an estimate of \$10/tCO₂, the total transportation costs were calculated by multiplying the amount of CO₂ captured per year [42] by \$10/tCO₂. Then, this total

⁸ In the IEAGHG (2013) study with natural gas-fired CCS, the amount of electricity generated is so large that it has a percent emissions avoided of 119%. This value indicates that the generation of electricity onsite is large enough to offset additional emissions offsite – for example, by generating its own electricity and selling it to the grid, it reduces the need for a powerplant offsite to generate CO₂ emissions.

transportation cost was divided by the actual annual production of cement to find the cost of CO₂ transportation and storage per unit of cement [50]. As stated previously, this cost component is included in the total cost of production [26].

Table 20 shows the cost table for the NETL (2014), Hegerland et al. (2006), and Cryogenic Carbon Capture (CCC) Studies. NETL (2014), Hegerland et al. (2006), and CCC did not include reference cement plants with their engineering and cost details, so the IEAGHG (2013) reference case was used as its reference plant. Therefore, in order to provide a direct comparison between CCS technologies, the inputs and costs for an IEAGHG (2013) reference plant were added to the costs for the individual CCS units. Specifically, the capital costs, variable O&M costs, fixed O&M costs, and fuel inputs were obtained from the reference case and added to the individual CCS costs.

Table 20. Costs of cement production with CCS, using engineering and cost data from NETL (2014), Hegerland et al. (2006), and CCC.

		Units	Reference Plant (IEA)	Cement w/ NG CCS (IEA + NETL)	Cement w/ NG CCS (IEA + Hegerland)	Cement w/ Coal CCS (IEA + Hegerland)	Cement w/ CCC
[1]	"Overnight" Capital Cost	\$/tonne	177	436	436	488	256
[2]	Total Capital Requirement	\$/tonne	205	505	505	566	297
[3]	Capital Recovery Charge Rate	%	10.57%	10.57%	10.57%	10.57%	10.57%
[4]	Fixed O&M	\$/tonne	19	33	24	24	20
[5]	Variable O&M	\$/tonne	7.4269	33.6260	10.7455	10.7455	8.5838
[6]	Project Life	years	20	20	20	20	20
[7]	Capacity Factor	%	80%	100%	84%	84%	90%
[8]	Maximum Cement Production	tonnes cement/year	1,360,000	992,500	1,400,000	1,400,000	1,660,620
[9]	Actual Cement Production	tonnes cement/year	1,088,000	992,500	1,176,000	1,176,000	1,494,558
[10]	Operating Hours	hours	7008	8760	7358.4	7358.4	7884
	Capital Recovery Required	\$/tonne	27.06	53.41	63.56	71.15	34.89
[11]	SCALED Capital Recovery Required	\$/tonne	29.76	58.75	69.92	78.27	38.38
[12]	Fixed O&M Recovery Required	\$/tonne	23.75	32.90	28.33	28.33	22.67
[13]	Total Coal Input/year	t/year	91,317	91,317	91,317	223,617	91,317
[14]	Coal Input	t coal/t cement	0.08	0.09	0.08	0.19	0.06
[15]	Coal Fuel Cost	\$/t	65.69	65.69	65.69	65.69	65.69
[16]	Coal Total Cost	\$/tonne	5.51	6.04	5.10	12.49	4.01
[17]	Total NG Input/year	Sm ³ /year	0	112,617,316	93,345,000	0	0
[18]	NG Input	Sm ³ /t cement	0.00	113.47	79.38	0.00	0.00
[19]	NG Fuel Cost	\$/Sm ³	0.13	0.13	0.13	0.13	0.13
[20]	NG Total Cost	\$/tonne	0.00	14.75	10.32	0.00	0.00

[21]	Total Electricity Input/year	MWh/year	131,920	295,736	155,920	155,920	393,680
[22]	Electricity Input	MWh/t cement	0.12	0.30	0.13	0.13	0.26
[23]	Electricity Cost	\$/MWh	89.70	89.70	89.70	89.70	89.70
[24]	Electricity Total Cost	\$/tonne	10.88	26.73	11.89	11.89	23.63
[25]	Fuel Cost per Tonne	\$/tonne	16.39	47.52	27.31	24.38	27.64
[26]	Total Cost of Production	\$/tonne	77.33	181.03	143.00	149.74	103.24
[27]	Markup Over Regular Plant		1.00	2.34	1.85	1.94	1.34
	Emissions						
[28]	CO ₂ Created from Cement	tCO ₂ /year	499,709	499,709	499,709	499,709	742,908
[29]	Carbon Content of Coal	tCO ₂ /tCoal	2.72	2.72	2.72	2.72	2.72
[30]	CO ₂ from Coal	tCO ₂ /year	248,381	248,381	248,381	608,237	248,381
[31]	Carbon Content of NG	tCO ₂ /Sm ³	0.0019	0.0019	0.0019	0.0019	0.0019
[32]	CO ₂ from NG	tCO ₂ /year	0	213,973	177,356	0	0
[33]	Carbon Content of Electricity	tCO ₂ /MWh	0.49	0.49	0.49	0.49	0.49
[34]	CO ₂ from Electricity	tCO ₂ /year	64,641	144,911	76,401	76,401	192,903
[35]	CO ₂ From Fuels + Cement	tCO ₂ /year	748,090	962,063	925,446	1,107,946	991,289
[36]	CO ₂ From Fuels + Cement + Electricity	tCO ₂ /year	812,731	1,106,974	1,001,846	1,184,347	1,184,192
[37]	CO ₂ Emissions per tonne Cement (Direct)	tCO ₂ /tonne cement	0.688	0.969	0.787	0.942	0.663
[38]	CO ₂ Emissions per tonne Cement (Total)	tCO ₂ /tonne cement	0.747	1.115	0.852	1.007	0.792
[39]	Percent CO ₂ Capture	%	0%	85%	85%	85%	90%
[40]	CO ₂ Emissions after Capture (Direct)	tCO ₂ /year	748,090	144,309	138,817	166,192	99,129
[41]	CO ₂ Emissions after Capture (Total)	tCO ₂ /year	812,731	289,220	215,218	242,593	292,032
[42]	CO ₂ Captured	tCO ₂ /year	0	817,753	786,629	941,754	892,160

[43]	CO ₂ Avoided (Direct)	tCO ₂ /year	-	603,781	609,273	581,898	648,961
[44]	CO ₂ Avoided (In-Direct + Direct)	tCO ₂ /year	-	523,511	597,513	570,138	520,699
[45]	% CO ₂ Avoided (Direct)	%	-	81%	81%	78%	87%
[46]	% CO ₂ Avoided (In-Direct + Direct)	%	-	64%	74%	70%	64%
[47]	\$/tCO ₂ Avoided (Direct)	\$/tCO ₂ Avoided	-	\$297.59	\$276.02	\$302.62	\$237.77
[48]	\$/tCO ₂ Avoided (Total)	\$/tCO ₂ Avoided	-	\$343.21	\$281.45	\$308.86	\$296.34
[49]	CO ₂ Transportation Costs	\$/year	\$0	\$8,177,535	\$7,866,287	\$9,417,541	\$8,921,601
[50]	CO ₂ Transportation Costs	\$/tonne cement	\$0	\$8.24	\$6.69	\$8.01	\$5.97

The cement production levels were provided by the individual CCS studies. For the NETL (2014) and Hegerland et al. (2006) studies, there was no estimated amount of CO₂ from the cement process, so the IEAGHG's (2013) estimate of 467,561 tonnes/year was used.⁹ **Figure 21** illustrates the differences in costs and cost components for all technologies.

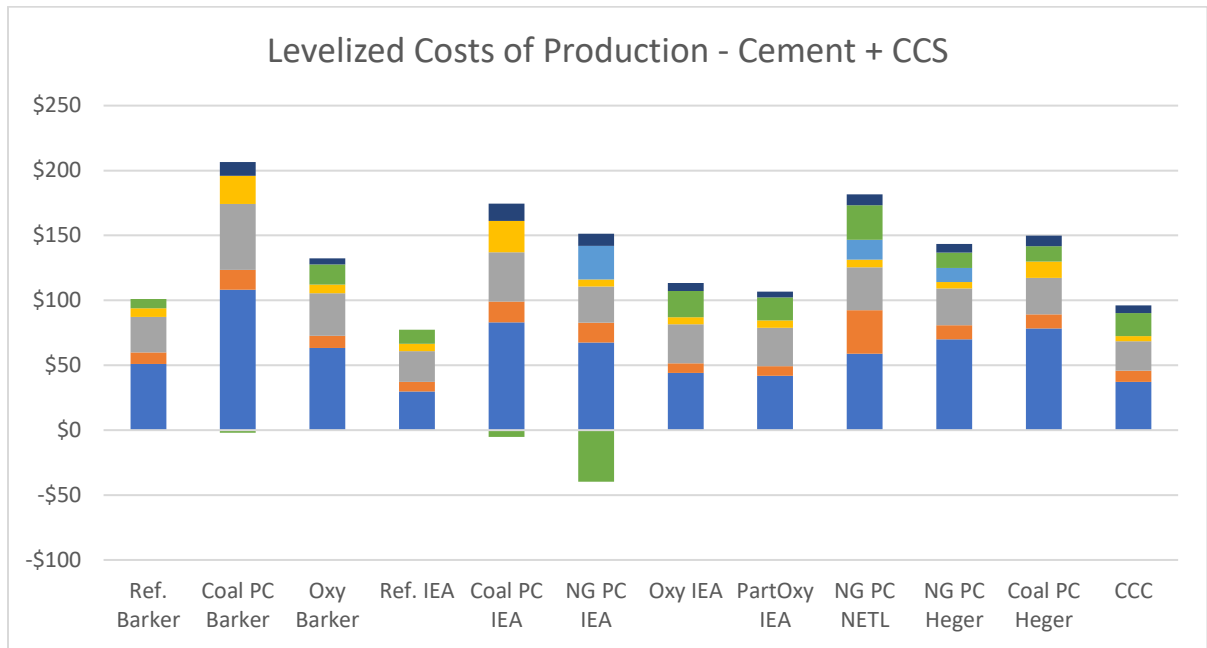

Figure 21. Levelized costs of production – cement with CCS.

A similar process was used to separate the cement plant from its CCS components in the Barker et al. (2009) and IEAGHG (2013) studies. In order to directly compare the costs of CCS technologies, it is helpful to group the technologies between coal-fired PCC, natural gas-fired PCC, and oxyfuel technologies. **Tables 21-23** group the CCS technologies by type to compare costs across the different studies. The costs represented in these tables are the additional costs of the CCS unit, including the additional fuels. The emissions provided in the tables are based on a

⁹ The CCC study provided its own estimates for cement CO₂ production

full cement plant with the CCS unit. **Figures 22-24** then illustrate the production costs by CCS technology type for the studies.

Table 21. Table with engineering and cost details of coal-fired PCC.

		Units	Coal-fired PCC Unit (Hegerland)	Coal-fired PCC Unit (IEA)	Coal-fired PCC Unit (Barker)
[1]	"Overnight" Capital Cost	\$/tonne	311	316	382
[2]	Total Capital Requirement	\$/tonne	361	367	443
[3]	Capital Recovery Charge Rate	%	10.57%	10.57%	10.57%
[4]	Fixed O&M	\$/tonne	4.8	11	21
[5]	Variable O&M	\$/tonne	3.3186	8.5606	6.468
[6]	Project Life	years	20	20	20
[7]	Capacity Factor	%	84%	80%	90%
[8]	Maximum Cement Production	tonnes cement/year	1,400,000	1,360,000	1,111,111
[9]	Actual Cement Production	tonnes cement/year	1,176,000	1,088,000	1,000,000
[10]	Operating Hours	hours	7358.4	7008	7884
	Capital Recovery Required	\$/tonne	45.38	48.45	51.97
[11]	SCALED Capital Recovery Required	\$/tonne	49.92	53.30	57.17
[12]	Fixed O&M Recovery Required	\$/tonne	5.71	14.25	23.33
[13]	Total Coal Input/year	t/year	132,300	308,349	228,300
[14]	Coal Input	t coal/t cement	0.11	0.28	0.23
[15]	Coal Fuel Cost	\$/t	65.69	65.69	65.69
[16]	Coal Total Cost	\$/tonne	7.39	18.62	15.00
[17]	Total NG Input/year	Sm ³ /year	0	0	0
[18]	NG Input	Sm ³ /t cement	0.00	0.00	0.00
[19]	NG Fuel Cost	\$/Sm ³	0.13	0.13	0.13
[20]	NG Total Cost	\$/tonne	0.00	0.00	0.00
[21]	Total Electricity Input/year	MWh/year	24,000	-194,971	-103,280
[22]	Electricity Input	MWh/t cement	0.02	-0.18	-0.10
[23]	Electricity Cost	\$/MWh	89.7	89.7	89.7
[24]	Electricity Total Cost	\$/tonne	1.83	-16.07	-9.26

[25]	Fuel Cost per Tonne	\$/tonne	9.22	2.54	5.73
[26]	Total Cost of Production	\$/tonne	74.39	89.72	102.23

Emissions

[28]	CO2 Created from Cement	tCO2/year	499,709	499,709	499,709
[29]	Carbon Content of Coal	tCO2/tCoal	2.72	2.72	2.72
[30]	CO2 from Coal	tCO2/year	359,856	838,709	620,976
[31]	Carbon Content of NG	tCO2/Sm3	0.0019	0.0019	0.0019
[32]	CO2 from NG	tCO2/year	0	0	0
[33]	Carbon Content of Electricity	tCO2/MWh	0.49	0.49	0.49
[34]	CO2 from Electricity	tCO2/year	11,760	-95,536	-50,607
[35]	CO2 From Fuels + Cement	tCO2/year	859,565	1,338,418	1,120,685
[36]	CO2 From Fuels + Cement + Electricity	tCO2/year	871,325	1,242,882	1,070,078
[37]	CO2 Emissions per tonne Cement (Direct)	tCO2/tonne cement	0.731	1.230	1.121
[38]	CO2 Emissions per tonne Cement (Total)	tCO2/tonne cement	0.741	1.142	1.070
[39]	Percent CO2 Capture	%	85%	90%	85%
[40]	CO2 Emissions after Capture (Direct)	tCO2/year	128,935	133,842	168,103
[41]	CO2 Emissions after Capture (Total)	tCO2/year	140,695	38,306	117,496
[42]	CO2 Captured	tCO2/year	730,630	1,204,576	952,582
[43]	CO2 Avoided (Direct)	tCO2/year	619,155	614,248	560,297
[44]	CO2 Avoided (In-Direct + Direct)	tCO2/year	672,036	774,425	650,309
[45]	% CO2 Avoided (Direct)	%	83%	82%	77%
[46]	% CO2 Avoided (In-Direct + Direct)	%	83%	95%	85%

[47]	\$/tCO2 Avoided (Direct)	\$/tCO2 Avoided	\$141.29	\$158.92	\$182.46
[48]	\$/tCO2 Avoided (Total)	\$/tCO2 Avoided	\$130.17	\$126.05	\$157.21

[49]	CO2 Transportation Costs	\$/year	\$7,306,300	\$12,045,763	\$9,525,820
[50]	CO2 Transportation Costs	\$/tonne cement	\$6.21	\$11.07	\$9.53

Figure 22 illustrates the production costs of coal-fired PCC units. Both IEAGHG (2013) and Barker et al. (2009) generate excess electricity that is sold to the electricity grid for additional revenue.

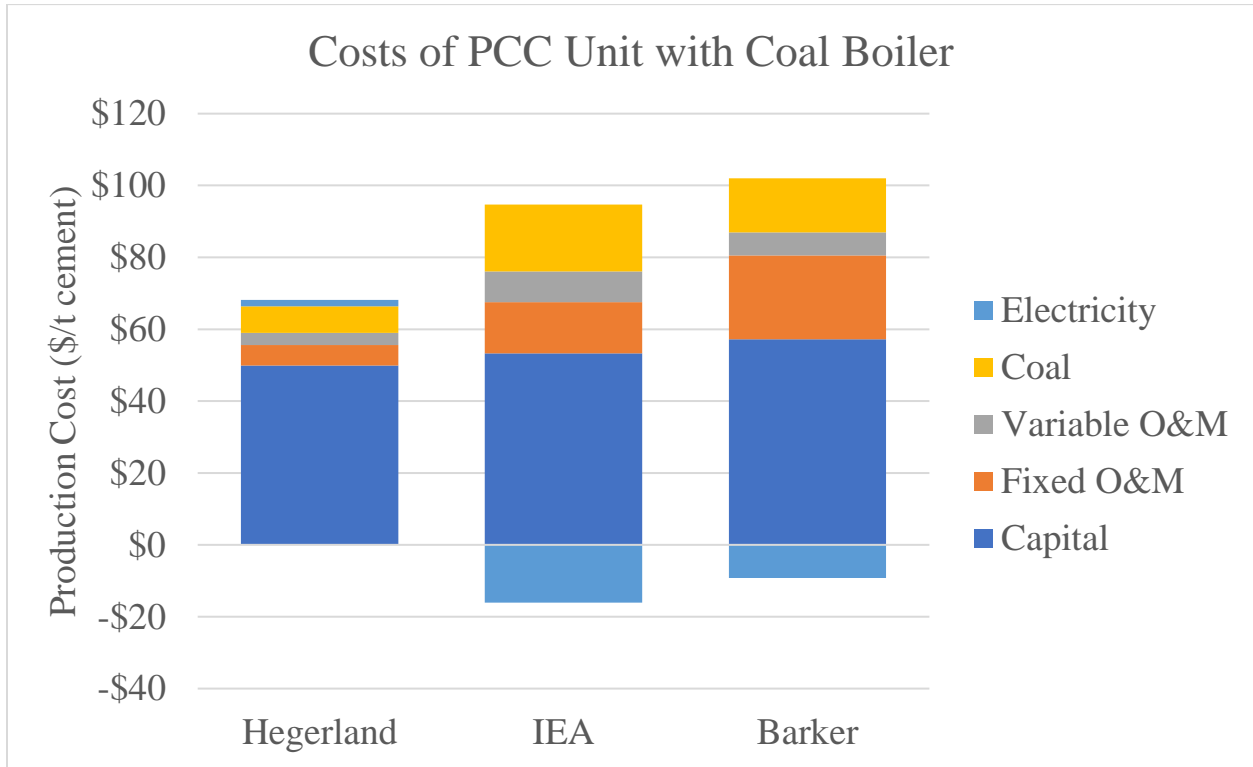

Figure 22. Costs of PCC Unit with Coal-fired Boiler

Table 22. Table with engineering and cost details of natural gas-fired PCC.

		Units	NG-fired PCC Unit (Hegerland)	NG-fired PCC Unit (IEA)	NG-fired PCC Unit (NETL)
[1]	"Overnight" Capital Cost	\$/tonne	259	223	259
[2]	Total Capital Requirement	\$/tonne	300	259	301
[3]	Capital Recovery Charge Rate	%	10.57%	10.57%	10.57%
[4]	Fixed O&M	\$/tonne	4.8	3.2	13.9
[5]	Variable O&M	\$/tonne	3.3186	8.8267	26.1991
[6]	Project Life	years	20	20	20
[7]	Capacity Factor	%	84%	80%	100%
[8]	Maximum Cement Production	tonnes cement/year	1,400,000	1,360,000	992,500
[9]	Actual Cement Production	tonnes cement/year	1,176,000	1,088,000	992,500
[10]	Operating Hours	hours	7358.4	7008	8760
	Capital Recovery Required	\$/tonne	37.79	34.22	31.76
[11]	SCALED Capital Recovery Required	\$/tonne	41.57	37.64	34.93
[12]	Fixed O&M Recovery Required	\$/tonne	5.71	4.00	13.90
[13]	Total Coal Input/year	t/year	0	0	0
[14]	Coal Input	t coal/t cement	0.00	0.00	0.00
[15]	Coal Fuel Cost	\$/t	65.69	65.69	65.69
[16]	Coal Total Cost	\$/tonne	0.00	0.00	0.00
[17]	Total NG Input/year	Sm ³ /year	93,345,000	235,713,078	112,617,316
[18]	NG Input	Sm ³ /t cement	79.38	216.65	113.47
[19]	NG Fuel Cost	\$/Sm ³	0.13	0.13	0.13
[20]	NG Total Cost	\$/tonne	10.32	28.16	14.75
[21]	Total Electricity Input/year	MWh/year	24,000	-615,211	163,816

[22]	Electricity Input	MWh/t cement	0.02	-0.57	0.17
[23]	Electricity Cost	\$/MWh	89.7	89.7	89.7
[24]	Electricity Total Cost	\$/tonne	1.83	-50.72	14.81
[25]	Fuel Cost per Tonne	\$/tonne	12.1493622	-22.556734	29.5562179
[26]	Total Cost of Production	\$/tonne	67.65	35.75	110.70

Emissions

[28]	CO ₂ Created from Cement	tCO ₂ /year	499,709	499,709	499,709
[29]	Carbon Content of Coal	tCO ₂ /tCoal	2.72	2.72	2.72
[30]	CO ₂ from Coal	tCO ₂ /year	0	0	0
[31]	Carbon Content of NG	tCO ₂ /Sm ³	0.0019	0.0019	0.0019
[32]	CO ₂ from NG	tCO ₂ /year	177355.5	447854.848	213972.9
[33]	Carbon Content of Electricity	tCO ₂ /MWh	0.49	0.49	0.49
[34]	CO ₂ from Electricity	tCO ₂ /year	11,760	-301,453	80,270
[35]	CO ₂ From Fuels + Cement	tCO ₂ /year	677,064	947,564	713,682
[36]	CO ₂ From Fuels + Cement + Electricity	tCO ₂ /year	688,824	646,110	793,951
[37]	CO ₂ Emissions per tonne Cement (Direct)	tCO ₂ /tonne cement	0.576	0.871	0.719
[38]	CO ₂ Emissions per tonne Cement (Total)	tCO ₂ /tonne cement	0.586	0.594	0.800
[39]	Percent CO ₂ Capture	%	85%	90%	85%
[40]	CO ₂ Emissions after Capture (Direct)	tCO ₂ /year	101,560	94,756	107,052
[41]	CO ₂ Emissions after Capture (Total)	tCO ₂ /year	113,320	-206,697	187,322
[42]	CO ₂ Captured	tCO ₂ /year	575,505	852,807	606,629
[43]	CO ₂ Avoided (Direct)	tCO ₂ /year	646,530	653,334	641,038
[44]	CO ₂ Avoided (In-Direct + Direct)	tCO ₂ /year	699,411	1,019,428	625,409

[45]	% CO ₂ Avoided (Direct)	%	86%	87%	86%
[46]	% CO ₂ Avoided (In-Direct + Direct)	%	86%	125%	77%
[47]	\$/tCO ₂ Avoided (Direct)	\$/tCO ₂ Avoided	\$123.05	\$59.54	\$171.40
[48]	\$/tCO ₂ Avoided (Total)	\$/tCO ₂ Avoided	\$113.75	\$38.16	\$175.68

[49]	CO ₂ Transportation Costs	\$/year	\$5,755,046	\$8,528,072	\$6,066,294
[50]	CO ₂ Transportation Costs	\$/tonne cement	\$4.89	\$7.84	\$6.11

Figure 23 illustrates the production costs of natural gas-fired PCC units. IEAGHG (2013)

generates excess electricity that is sold to the electricity grid for additional revenue.

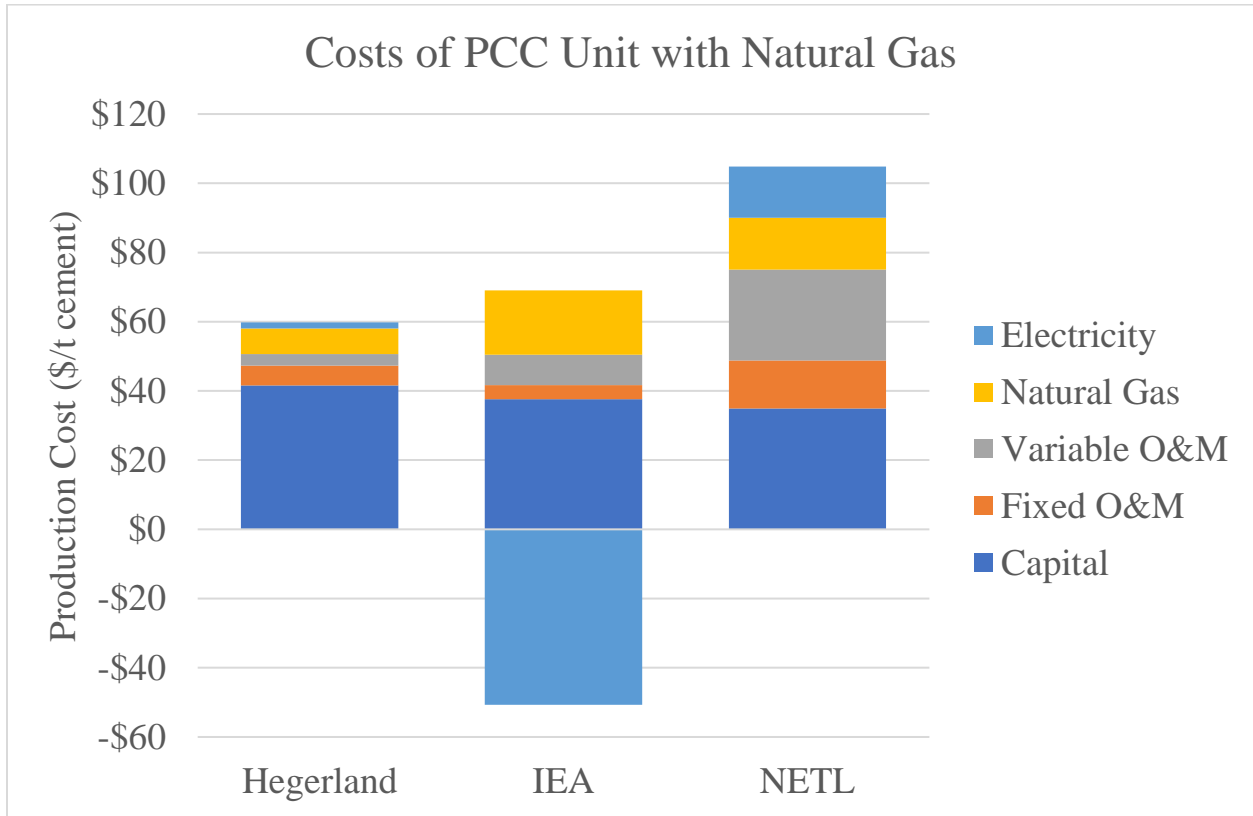

Figure 23. Costs of PCC Unit with Natural Gas-fired Boiler

Table 23. Table with engineering and cost details of CCS primarily using electricity.

		Units	Oxyfuel (Barker)	Oxyfuel (IEA)	Partial Oxyfuel (IEA)	CCC
[1]	"Overnight" Capital Cost	\$/tonne	83	85	71	72
[2]	Total Capital Requirement	\$/tonne	96	99	82	83
[3]	Capital Recovery Charge Rate	%	10.57%	10.57%	10.57%	10.57%
[4]	Fixed O&M	\$/tonne	4.8	5	4.8	1.4
[5]	Variable O&M	\$/tonne	0.4312	0.8184	0.8038	1.1569
[6]	Project Life	years	20	20	20	20
[7]	Capacity Factor	%	90%	80%	80%	90%
[8]	Maximum Cement Production	tonnes cement/year	1,111,111	1,360,000	1,360,000	1,660,620
[9]	Actual Cement Production	tonnes cement/year	1,000,000	1,088,000	1,088,000	1,494,558
[10]	Operating Hours	hours	7884	7008	7008	7884
	Capital Recovery Required	\$/tonne	11.28	13.07	10.89	9.78
[11]	SCALED Capital Recovery Required	\$/tonne	12.40	14.37	11.98	10.76
[12]	Fixed O&M Recovery Required	\$/tonne	5.33	6.25	6.00	1.56
[13]	Total Coal Input/year	t/year	2,179	0	0	0
[14]	Coal Input	t coal/t cement	0.00	0.00	0.00	0.00
[15]	Coal Fuel Cost	\$/t	65.69	65.69	65.69	65.69
[16]	Coal Total Cost	\$/tonne	0.14	0.00	0.00	0.00
[17]	Total NG Input/year	Sm ³ /year	0	0	0	0
[18]	NG Input	Sm ³ /t cement	0.00	0.00	0.00	0.00
[19]	NG Fuel Cost	\$/Sm ³	0.13	0.13	0.13	0.13

[20]	NG Total Cost	\$/tonne	0.00	0.00	0.00	0.00
[21]	Total Electricity Input/year	MWh/year	93,031	112,389	85,189	162,195
[22]	Electricity Input	MWh/t cement	0.09	0.10	0.08	0.11
[23]	Electricity Cost	\$/MWh	89.7	89.7	89.7	89.7
[24]	Electricity Total Cost	\$/tonne	8.34	9.27	7.02	9.73
[25]	Fuel Cost per Tonne	\$/tonne	8.48802	9.265895	7.023395	9.73458
[26]	Total Cost of Production	\$/tonne	29.79	34.84	28.79	27.68

Emissions

[28]	CO ₂ Created from Cement	tCO ₂ /year	499,709	499,709	499,709	742,908
[29]	Carbon Content of Coal	tCO ₂ /tCoal	2.72	2.72	2.72	2.72
[30]	CO ₂ from Coal	tCO ₂ /year	5,927	0	0	0
[31]	Carbon Content of NG	tCO ₂ /Sm ³	0.0019	0.0019	0.0019	0.0019
[32]	CO ₂ from NG	tCO ₂ /year	0	0	0	0
[33]	Carbon Content of Electricity	tCO ₂ /MWh	0.49	0.49	0.49	0.49
[34]	CO ₂ from Electricity	tCO ₂ /year	45,585	55,071	41,743	128,262
[35]	CO ₂ From Fuels + Cement	tCO ₂ /year	505,636	499,709	499,709	742,908
[36]	CO ₂ From Fuels + Cement + Electricity	tCO ₂ /year	551,221	554,779	541,451	871,170
[37]	CO ₂ Emissions per tonne Cement (Direct)	tCO ₂ /tonne cement	0.506	0.459	0.459	0.497
[38]	CO ₂ Emissions per tonne Cement (Total)	tCO ₂ /tonne cement	0.551	0.510	0.498	0.550
[39]	Percent CO ₂ Capture	%	62%	90%	65%	90%
[40]	CO ₂ Emissions after Capture (Direct)	tCO ₂ /year	192,142	49,971	174,898	74,291
[41]	CO ₂ Emissions after Capture (Total)	tCO ₂ /year	237,727	105,041	216,641	153,766
[42]	CO ₂ Captured	tCO ₂ /year	313,494	449,738	324,811	668,617
[43]	CO ₂ Avoided (Direct)	tCO ₂ /year	536,258	698,119	573,192	673,799

[44]	CO ₂ Avoided (In-Direct + Direct)	tCO ₂ /year	530,078	707,689	596,090	658,964
[45]	% CO ₂ Avoided (Direct)	%	74%	93%	77%	90%
[46]	% CO ₂ Avoided (In-Direct + Direct)	%	69%	87%	73%	81%
[47]	\$/tCO ₂ Avoided (Direct)	\$/tCO ₂ Avoided	\$55.55	\$54.30	\$54.64	\$61.40
[48]	\$/tCO ₂ Avoided (Total)	\$/tCO ₂ Avoided	\$56.20	\$53.57	\$52.55	\$62.78
[49]	CO ₂ Transportation Costs	\$/year	\$3,134,941	\$4,497,378	\$3,248,107	\$6,686,169
[50]	CO ₂ Transportation Costs	\$/tonne cement	\$3.13	\$4.13	\$2.99	\$4.47

Figure 24 illustrates the production costs of CCS units primarily using electricity.

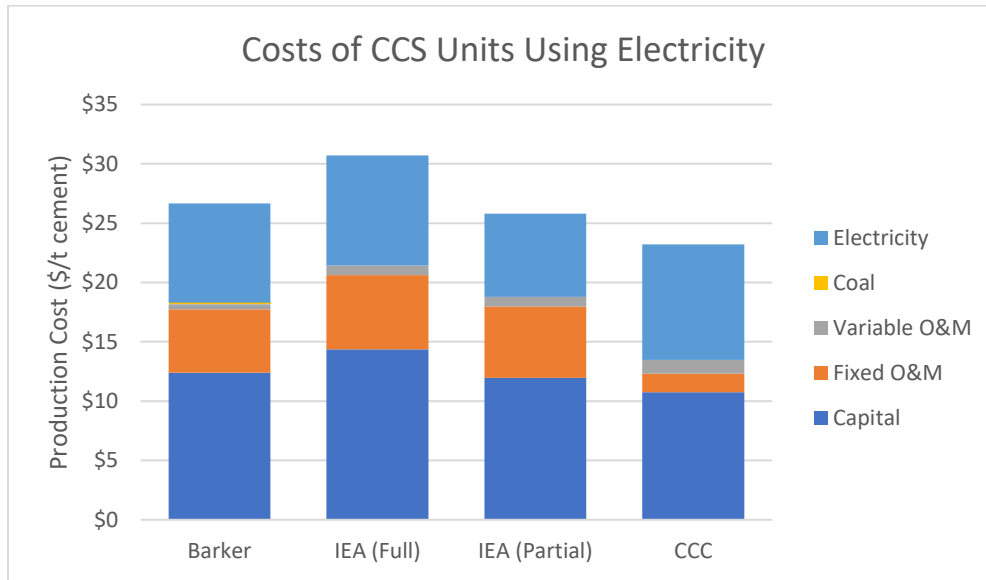

Figure 24. Costs of CCS Units Using Electricity

By using standardized assumptions I have created cost metrics that can be used to directly compare the cost of various CCS technologies using data and estimates from different studies. However, these costs do not account for regional variation. My approach for capturing such regional variation is described below.

ii. Regional Variation

In order to account for regional variations in the costs of capital and fuel prices, the following methodology was used.

A capital scalar was used to account for inherent capital cost differences in various regions. In order to calculate this scaling factor, IEA data on the capital costs of electricity-generating technologies were used. First, each region’s capital cost average was computed, weighted based on the prevalence of the technology in that region. Then, that region’s weighted average was divided by the world’s weighted average of capital costs. This yielded that region’s capital scaling

factor. The United States, for example, has a capital scaling factor of 1.10. This indicates that the cost of capital in the United States is 10% greater than the global median cost of capital provided by the IEA. Mexico, on the other hand, has a capital scaling factor of 0.44, which indicates the costs of capital in Mexico are 56% lower than the global median costs of capital. The capital scaling factors in the Middle East, Indonesia, and Russia were much lower than 1.0, however, so they were adjusted to match the capital scaling factors in China, while the capital scaling factor in Brazil was significantly higher than 1.0 and was adjusted to match the capital scaling factor in Central and South America. The regional variations in capital scalars is shown in **Figure 25**.

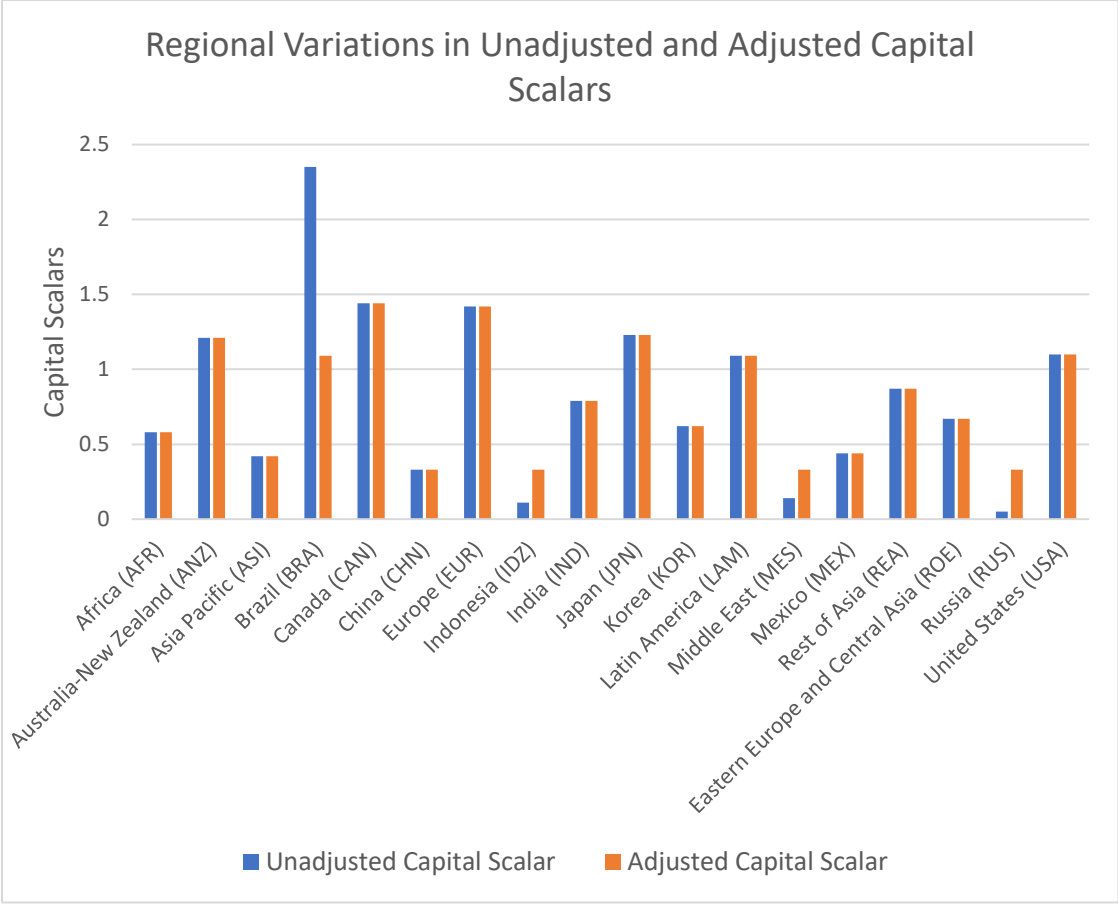

Figure 25. Regional Variations in Unadjusted and Adjusted Capital Scalars.

In order to account for variations in fuel price, GTAP data on fuel costs by region were used. Using the reference cost of coal and natural gas in the United States, the relative price difference was used to estimate the cost per tonne of coal and the cost per standard meter cubed of natural gas. The scaling factors for eighteen different regions are shown in **Table 24**, along with each region's specific GTAP electricity and fuel price for coal and natural gas.

Table 24. Regional variations in prices of electricity, coal, and natural gas, and regional variations in capital.

Region	Electricity \$/MWh	Coal \$/ton	Gas \$/ton	Capital Scalar
Africa (AFR)	64.24	41.08	0.14	0.58
Australia-New Zealand (ANZ)	100.98	77.41	0.18	1.21
Asia Pacific (ASI)	77.57	76.33	0.21	0.42
Brazil (BRA)	105.96	92.81	0.13	1.09
Canada (CAN)	72.54	64.43	0.17	1.44
China (CHN)	50.54	49.11	0.23	0.33
Europe (EUR)	139.09	84.94	0.24	1.42
Indonesia (IDZ)	72.67	55.55	0.15	0.33
India (IND)	89.14	43.27	0.20	0.79
Japan (JPN)	146.47	85.99	0.23	1.23
Korea (KOR)	80.23	78.46	0.27	0.62
Latin America (LAM)	89.88	79.37	0.06	1.09
Middle East (MES)	88.77	79.03	0.11	0.33
Mexico (MEX)	95.70	73.34	0.19	0.44
Rest of Asia (REA)	105.95	70.12	0.17	0.87
Eastern Europe and Central Asia (ROE)	91.74	80.24	0.20	0.67
Russia (RUS)	31.89	51.68	0.14	0.33
United States (USA)	89.70	65.69	0.13	1.10

The regional variations in capital and fuel prices affect the levelized cost of production for the various cement plants. For example, depending on the capital scalar factor and the fuel prices, the estimated levelized cost of production for a reference cement plant using the IEA values varies between \$43 and \$84 per tonne of cement produced. In addition to the different costs of production,

the distribution of costs between capital, O&M, and fuel also vary significantly by region. For example, in the European region, capital costs make up 41% of the total costs, while capital costs make up 15% of costs in the Middle East region. The cost breakdown for a reference cement plant (IEA) is shown in **Figure 26**.

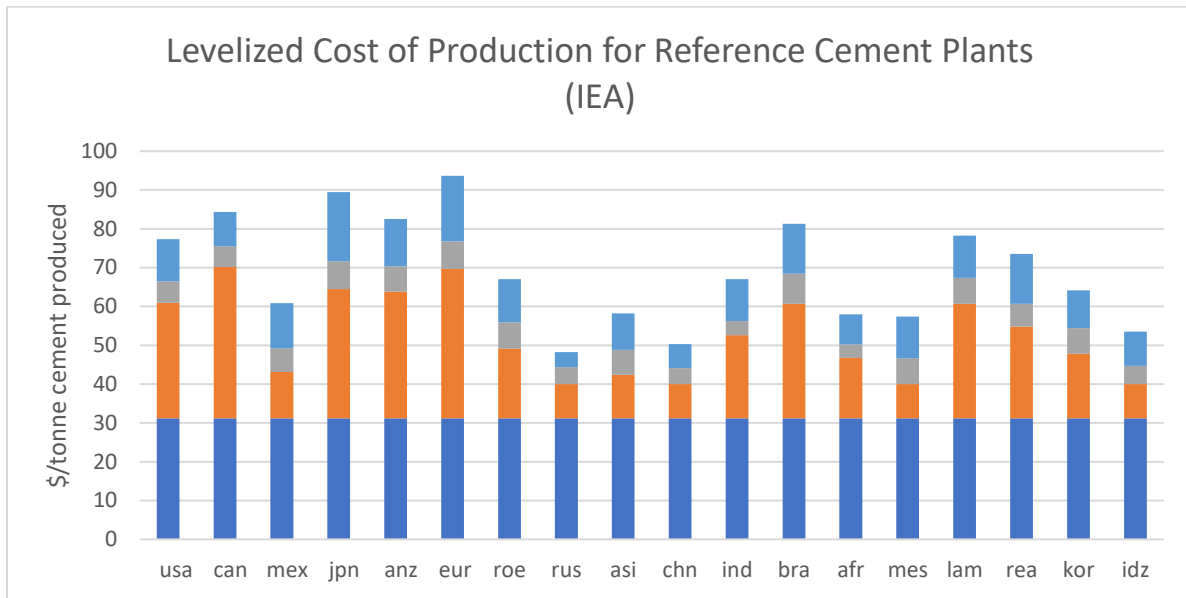

Figure 26. Levelized Cost of Production for Reference Cement Plants (using IEA data)

iii. Cement with CCS in Energy-Economic Models

Having calculated standardized and regional cost estimates for cement CCS technologies, the next step is to add the cement CCS technologies into an energy-economic model in order to conduct analysis on their potential role in the industrial sector. I use the MIT Economic Projection and Policy Analysis (EPPA) model, which is a general equilibrium economic model that spans 18 different regions and 10 sectors. It is based on economic theory with endogenous prices. The model allows for international trade, inter-industry linkages, distortions (including taxes and subsidies), and determines GDP and welfare effects. The model tracks the carbon emissions of each industry

and technology (including industrial CCS, CCS in the power sector, renewables, and nuclear power, among others). The EPPA model offers an analytic tool that includes a technology-rich representation of power generation sector and also captures interactions between all sectors of the economy, accounting for changes in international trade. Because of these allowances, one drawback of the model is that it must aggregate both regional and technological representation. **Figure 27** shows the 18 different regions in EPPA, and **Figure 28** shows the 10 different sectors, including crops, livestock, forestry, food, energy intensive industries, manufacturing, services, industrial transportation, household transportation, and energy. Data on production, consumption, intermediate inputs, international trade, energy and taxes for the base year of 2007 are from the Global Trade Analysis Project (GTAP) dataset (Narayanan et al. 2012). The model includes representation of CO₂ and non-CO₂ (methane, CH₄; nitrous oxide, N₂O; hydrofluorocarbons, HFCs; perfluorocarbons, PFCs; and sulphur hexafluoride, SF₆) greenhouse gas (GHG) emissions abatement, and calculates reductions from gas-specific control measures as well as those occurring as a byproduct of actions directed at CO₂. The model also tracks major air pollutants (sulfates, SO_x; nitrogen oxides, NO_x; black carbon, BC; organic carbon, OC; carbon monoxide, CO; ammonia, NH₃; and non-methane volatile organic compounds, VOCs). The data on GHG and air pollutants are documented in Waugh et al., (2011).

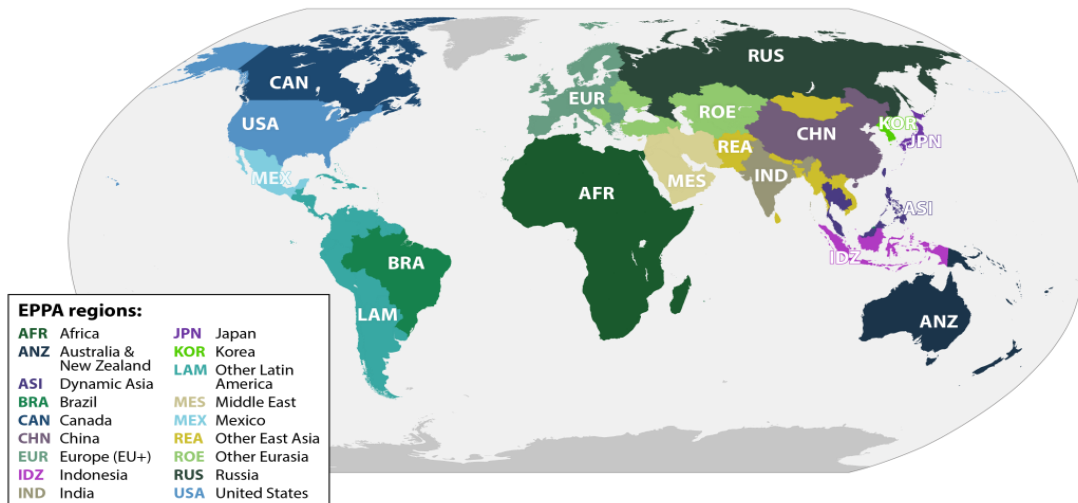

Figure 27. Regional representation in EPPA.

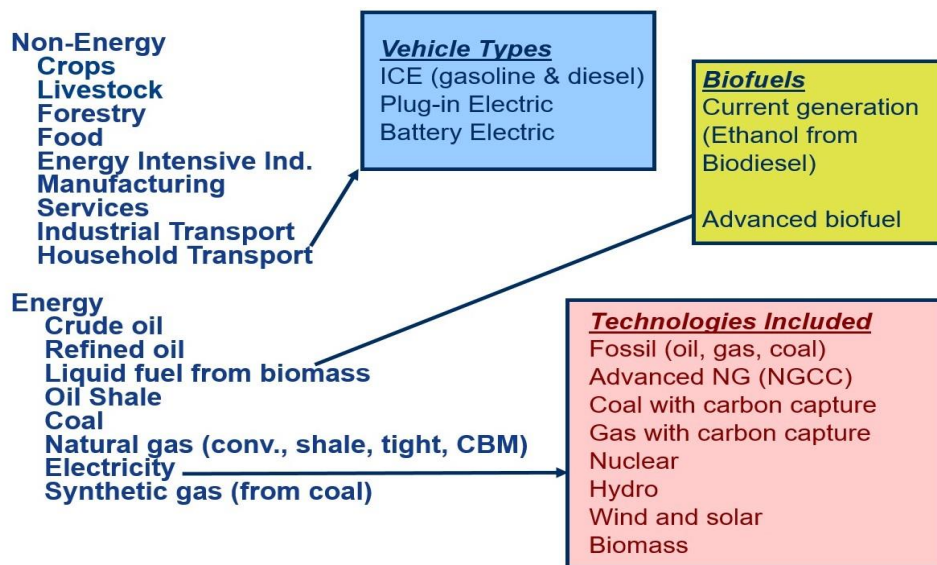

Figure 28. Sectoral representation in EPPA.

Currently, “Energy Intensive Industries” are represented by a single sector (EINT) in a production block in EPPA producing energy intensive goods. Included in the EINT sector is paper product manufacturing, chemical and plastic manufacturing, mineral product manufacturing, iron

and steel production, and cement production.¹⁰ While this study has primarily focused on CCS for cement production, it is assumed that the costs and input shares of CCS in the cement sector can be applicable to other industries. Therefore, in the cases below, CCS is included as a general option for the entire EINT sector. Further work will seek to disaggregate the energy-intensive sector to better represent the impact of CCS into the energy-intensive sector.

From 2015 the model solves at 5-year intervals, with economic growth and energy use for 2010-2015 calibrated to data and short-term projections from the International Monetary Fund (IMF, 2018) and the International Energy Agency (IEA, 2017). Each interval is solved using economic principles of supply and demand and utility maximization. For the benchmark year, the model requires inputs on each technology's costs in the base-year of the model in different regions. The two inputs required are markups and cost shares.

The markup is defined as the increased cost of a new technology relative to a base price. In EPPA, the markup for electricity generation technologies is the percent increase in cost from the price of electricity generation in the given country. For example, if a natural gas combined cycle unit has a cost of electricity generation of \$0.05/kWh and the cost of electricity is \$0.0897/kWh, the markup of the natural gas unit is 0.557. In the cement production, the markup is defined as the percent increase in production cost in \$/metric ton of cement production from a reference plant.

While the markup describes the increase in costs for a cement with CCS plant, the cost shares determine how much of each input is needed to create a single production unit of cement. By design, the cost shares of the EINT sector sum to 1.0. The costs of a new technology are broken

¹⁰ Petrochemical production is not included in the EINT sector; it is instead included in the Refined Oil (ROIL) sector

down into 18 separate categories, 12 of which are shown in **Table 25**. The remaining sectors are grouped into the “other” category. For example, in the energy-intensive sector in the United States, the costs of labor make up approximately 24.75% of the cost inputs to creating a unit of cement.

Table 25. Cost components of the energy-intensive sector.

Sector	Sector Description	Cost Share
EINT	Energy-Intensive Industries	0.3052
Serv	Services	0.1413
Tran	Transport	0.043
Coal	Coal	0.0006
Roil	Refined Oil	0.0227
Gas	Gas	0.009
Elec	Electricity	0.0467
Labor	Labor	0.2475
Capital	Capital	0.1197
LSEQ	Labor for Sequestration	0.000
KSEQ	Capital for Sequestration	0.000
Other	Other Industries	0.0642
Total		1.000

The cost shares for the cement with CCS industry were calculated using the costs from the LCOP table inputs described above. **Table 26** shows an example calculation for the additional cost shares for an oxyfuel CCS technology in Barker et al. (2009).

Table 26. Calculation of cost shares for EPPA.

Cement with Oxyfuel (Barker) (USA)					
Inputs	Reference Costs (\$/t)	Imported Cement with CCS Costs (\$/t)	Cement with CCS Costs (\$/t)	Cost Difference	Weighted Difference
Labor	\$36.21	\$41.98	\$36.21	\$0.00	0.000
Capital	\$50.97	\$63.37	\$50.97	\$0.00	0.000
Coal	\$6.63	\$6.77	\$6.77	\$0.14	0.001
Natural Gas	\$0.00	\$0.00	\$0.00	\$0.00	0.000
Electricity	\$7.21	\$15.56	\$15.56	\$8.34	0.083
CO ₂ T&S	\$0.00	\$4.64	\$0.00	\$0.00	0.000
LSEQ	\$0.00	\$0.00	\$7.23	\$7.23	0.072

KSEQ	\$0.00	\$0.00	\$15.58	\$15.58	0.154
Sum	\$101.02	\$132.32	\$132.32	\$31.30	0.313

First, the costs of a reference cement plant are imported into the table. The costs of labor are the sum of the variable O&M [5] and fixed O&M [12] in the levelized cost table, and the cost of capital is the value of the scaled capital recovery required [11]. The fuel costs of coal, natural gas, and electricity are obtained from the levelized cost table's total coal costs [13], natural gas costs [17], and electricity [21]. For the reference plant, no CO₂ capture and/or storage is taking place, so the values of LSEQ and KSEQ are zero. This import is continued for the cement with CCS plant, with the values of LSEQ and KSEQ remaining zero. In order to calculate the labor and capital needed to capture and store CO₂, the following equations are used:

$$L = (\text{Labor Costs})_{CCS} - (\text{Labor Costs})_{Reference}$$

$$K = (\text{Capital Costs})_{CCS} - (\text{Capital Costs})_{Reference}$$

$$L\% = \frac{L}{L + K}$$

$$K\% = \frac{K}{L + K}$$

$$LSEQ = L + (L\% * CO_2 \text{ T\&S Costs})$$

$$KSEQ = K + (K\% * CO_2 \text{ T\&S Costs})$$

Using these equations, the values of LSEQ and KSEQ are found, with the values of L and K being equivalent to the costs of L and K for the reference plant. The difference between the costs of the reference plant and the costs of the cement plant are then calculated. The percent increase (or the percent markup) is then divided by this difference to determine the weighted shares of each

additional cost input. For example, if the costs of electricity in a reference plant are \$7.21/t production, and the costs of electricity in a cement plant with CCC are \$15.56, the difference in costs is \$8.35. Then, by dividing the percent markup (31%) by the sum of the differences in costs and by multiplying by the cost difference of electricity, the share of additional costs being electricity is 0.083. These weighted differences are then added to the EINT cost shares currently in EPPA, shown in **Table 27**. This yields a sum of shares of 1.24, which is equivalent to the markup. These final cost shares are computed separately for each region, which has varying capital, labor, and fuel costs and different EINT cost shares. The cost shares for the Hegerland et al. (2006) CCS technologies for coal-fired and natural gas-fired PCC were evaluated using EPPA, along with the cost shares for the CCC electricity-fueled CCS unit. These cost shares were used primarily because the CCS units did not generate excess electricity to the grid, which would make them producers of both EINT and electricity in EPPA. In order to simplify the calculations, the Hegerland et al. (2006) shares were used, and a sensitivity case was ran to simulate lower costs from the sale of electricity. **Table 27** and **Figure 29** lists the cost share inputs for the Hegerland et al. (2006) coal- and natural gas-fired PCC and for the CCC.

Table 27. Cost input shares for CCC, coal-fired PCC, and natural gas-fired PCC.

	EINT (Reference Plant)	CCC	Hegerland Coal- fired PCC	Hegerland Natural Gas-fired PCC
EINT	0.3052	0.3052	0.3052	0.3052
Serv	0.1413	0.1413	0.1413	0.1413
Tran	0.043	0.043	0.043	0.043
Coal	0.0006	0.0004	0.0908	0.0006
Roil	0.0227	0.0227	0.0227	0.0227
Gas	0.009	0.009	0.009	0.1462
Elec	0.0467	0.1279	0.0598	0.0598
Labor	0.2475	0.2475	0.2475	0.2475
Capital	0.1197	0.1197	0.1197	0.1197
LSEQ	0	0.0016	0.1166	0.1156
KSEQ	0	0.1605	0.7166	0.5882

Other	0.0642	0.0642	0.0642	0.0642
Total	1.000	1.243	1.936	1.854

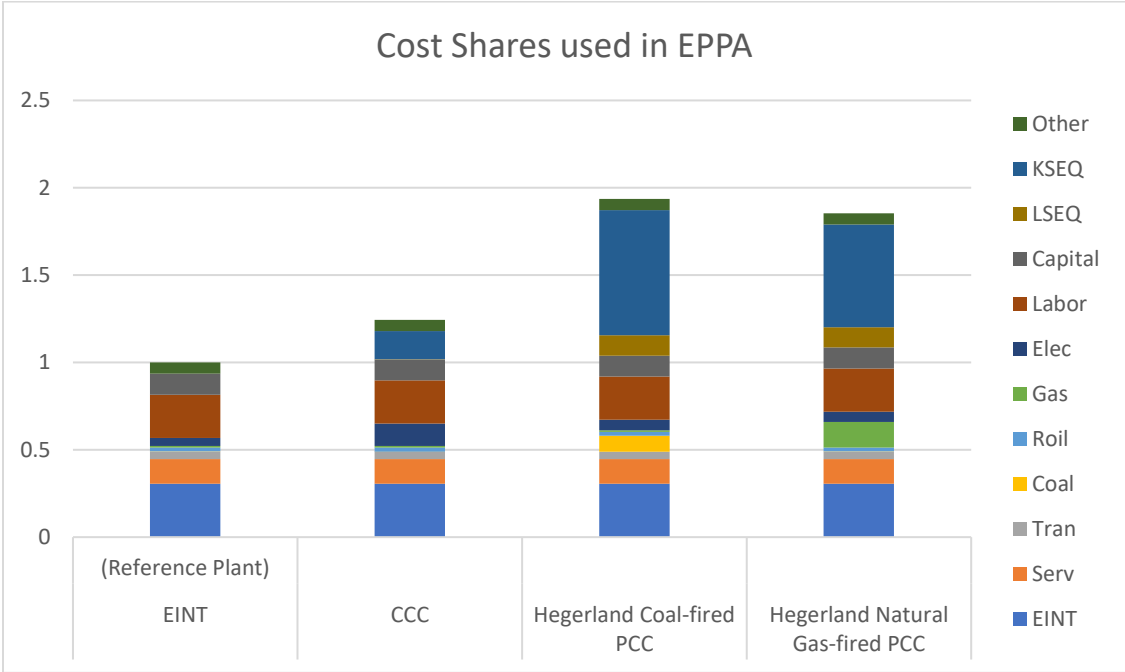

Figure 28. Cost shares used in EPPA for cost analysis.

The production of EINT depends on the relative costs of inputs and the value of EINT goods in the marketplace. Because a cement plant with CCS produces the exact same good as a regular cement plant, in the model, cement with CCS is modeled as an alternative technology to a regular cement plant, producing the same unit of cement with a larger share of input costs and with fewer emissions. The increased amount of fuel use for a cement with CCS plant is included in the additional costs, in addition to capital and labor required for the CCS equipment and transportation and storage of the CO₂. Because combustion and non-combustion emissions are calculated separately in the model, CCS is estimated to remove 90% of the combustion emissions produced and 90% of non-combustion emissions produced. However, since the CCS plant uses a larger amount of coal or natural gas than a traditional plant, the actual rate of CO₂ reduction is closer to

the value of CO₂ avoided. For example, in Hegerland et al. (2006), the percent CO₂ avoided by using a coal-fired boiler to power PCC is 78%, while the rate of capture is stated to be 85%.

VII. Results

With cement CCS technologies now represented in the model, I am able to conduct analysis on their potential role in the industrial sector. I do so under several scenarios. Under a reference scenario in EPPA under Business as Usual (BAU) GDP projections provided by the IMF World Economic Outlook, CO₂ emissions continue to rise in all regions. Under a policy scenario in EPPA, a quantity target was used that requires all 18 EPPA regions to reduce their emissions by 90% in 2100 relative to 2007 levels. This is equivalent to limiting the cumulative global CO₂-eq emissions from 2020-2100 to 496,402 million metric tons. This is approximately equal to an 80% chance of limiting warming to 2C. Under this scenario, countries are allowed to engage in global emissions trading. In addition, the use of biofuels is removed from these scenarios, preventing biofuels from replacing the use of refined oil in the industrial sector.

The following scenarios were evaluated. First, a reference case without any emissions targets was run. Next, a 2C policy case (which is consistent with limiting emissions below 2C by approximately 80%) was run without the availability of industrial CCS. Next, the 2C policy case was run with the introduction of industrial CCC, coal-fired PCC, and natural gas-fired PCC. In each scenario, the global and regional production of industrial goods, regional CO₂ emissions, and global consumption are analyzed.¹¹

i. Reference Case

¹¹ Emissions included in the following analysis exclude emissions from land-use, and only include CO₂. While other GHG emissions are tracked within EPPA, the reduction of CO₂ emissions was the primary focus of this study.

In order to compare the industrial production and emissions from a global economy with and without a carbon policy, a reference case under BAU conditions with no carbon policy was run with industrial CCS as a technology option. Overall, cement production is larger than in any other scenario, with 2100 production at 8.06 times the levels in 2010. **Figure 30** shows the regional production of EINT. The largest producers of energy-intensive goods are China, Europe, and the United States.

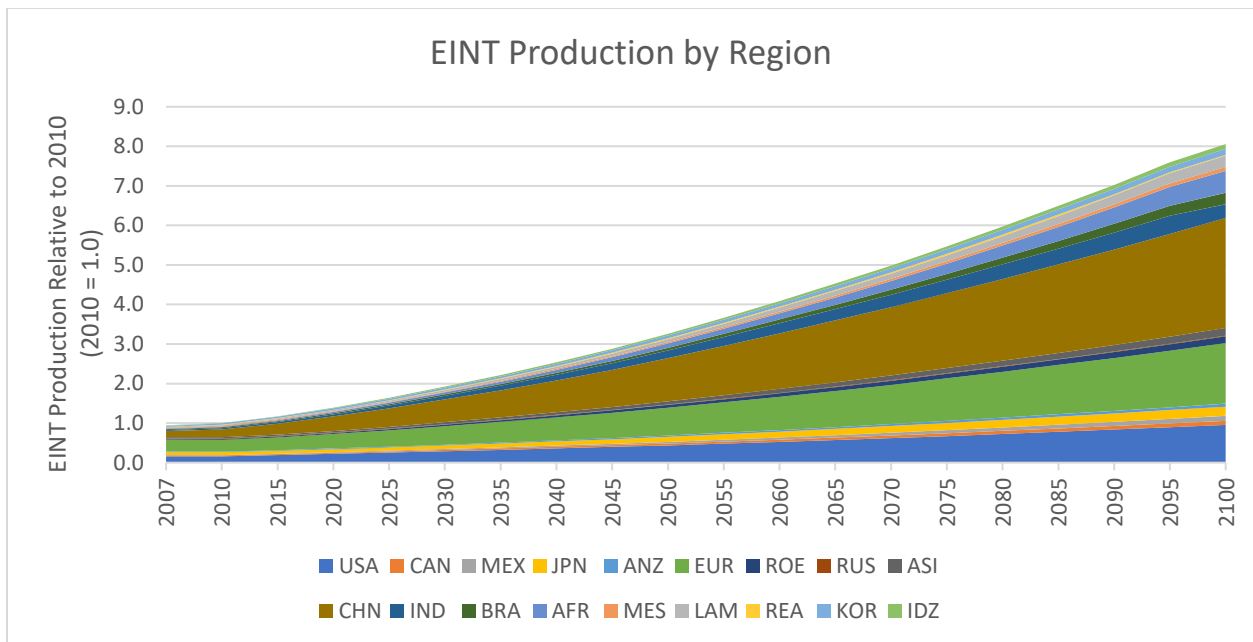

Figure 30. EINT Production by Region in the Reference Case.

At its production peak in 2100, the industrial sector emitted approximately 26,542 million metric tons of CO₂. From 2010 to 2100, 298,916 million metric tons of CO₂ were emitted from the EINT sector. Global emissions under the reference case in 2100 rise 133% from 2010 levels, with increases in industrial emissions of 362% (from 5,750 million metric tons in 2010 to 26,542 million metric tons in 2100). In 2100, industrial emissions (including combustion and non-combustion emissions) make up approximately 39.7% of all emissions. The largest total growth of EINT emissions occurs in China, growing from 1,800 million metric tons in 2010 to 8,449 million metric

tons in 2100. **Figure 31** shows global sectoral emissions, and **Figure 32** shows the emissions by sector in the United States (USA), Europe (EUR), China (CHN), and India (IND).

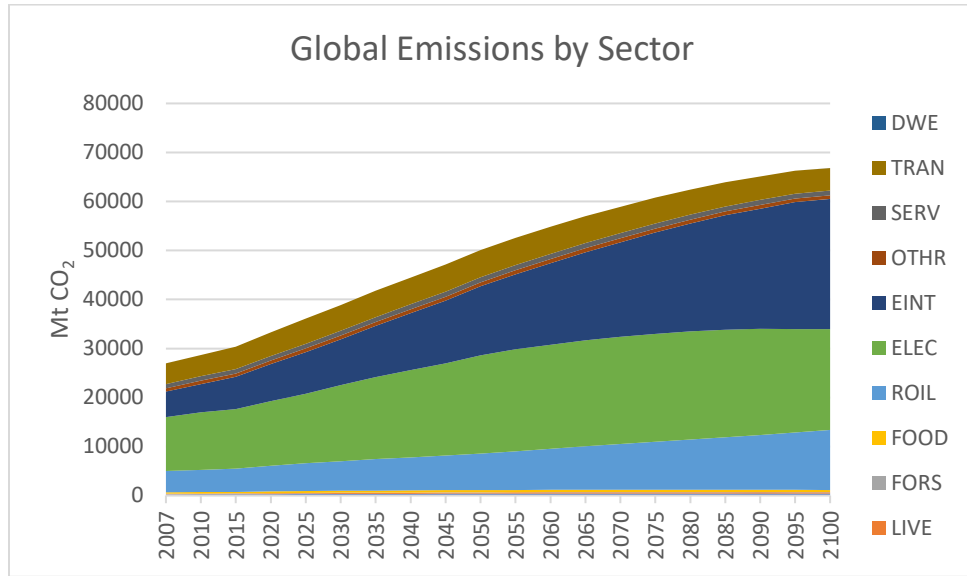

Figure 31. Global Emissions by Sector in the Reference Case.

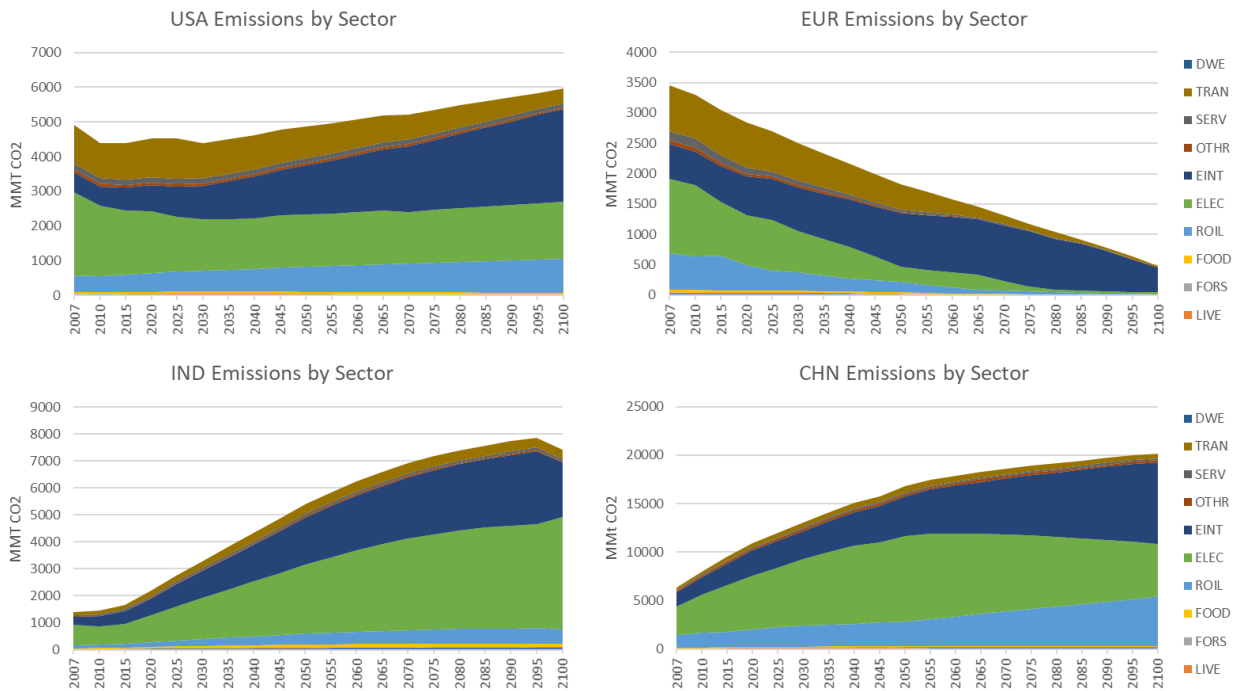

Figure 32. Regional Emissions by Sector in the Reference Case.

ii. *Policy without Industrial CCS*

In this scenario, industrial CCS (i.e. EINT with CCS) was not allowed in the world economy. Therefore, there were no alternatives to industrial processes, and the only emissions reduction opportunities would be through fuel switching and electrification. **Figure 33** shows the estimated EINT production in a 2C scenario without CCS as an emissions mitigation option. EINT production peaks in 2075 at approximately 3.52 times the 2010 EINT production. Global EINT production is significantly reduced relative to the reference scenario.

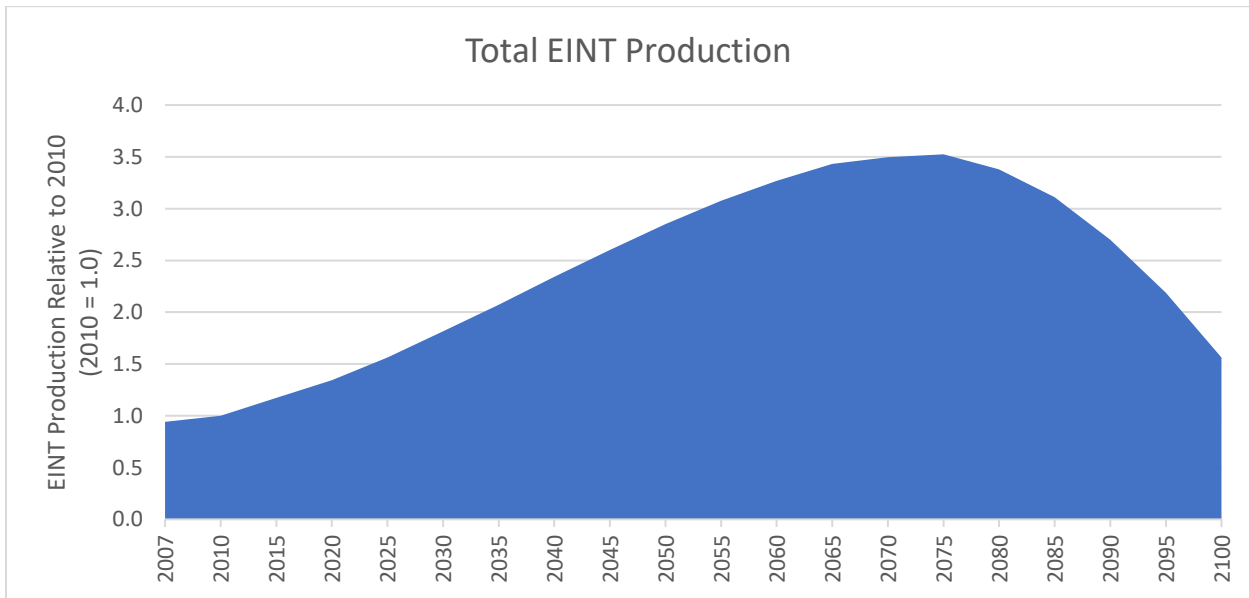

Figure 33. Total Global EINT Production under a 2C Policy without industrial CCS.

The largest producers of EINT in this scenario are China, Europe, the United States, and India, as shown in **Figure 34**.

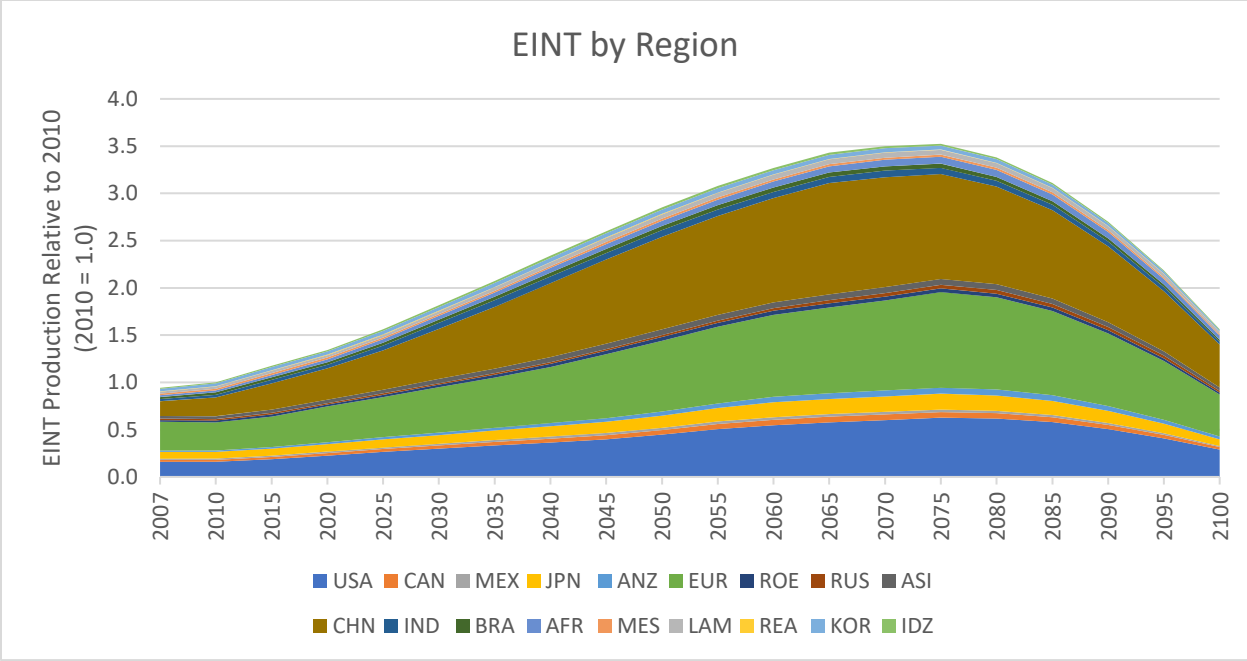

Figure 34. EINT Production by Region under a 2C Policy without industrial CCS.

At its production peak in 2075, the industrial sector emitted approximately 8,470 million metric tons of CO₂. From 2010 to 2100, 88,445 million metric tons of CO₂ were emitted from the EINT sector, a 70% reduction in cumulative EINT emissions relative to the reference case. When there is no availability of cement with CCS in EPPA, global emissions relative to 2010 levels are reduced by 88.8% by 2100. EINT emissions fell by 45.7% relative to 2010 levels, primarily due to the improvements in plant efficiency and fuel switching. Emissions from electricity and transportation decreased by 99.6% and 99.9%, respectively. By the end of the century, even with reduced production, emissions from the industrial sector make up 96.9% of all emissions in the world economy. **Figure 35** shows the global emissions by sector.

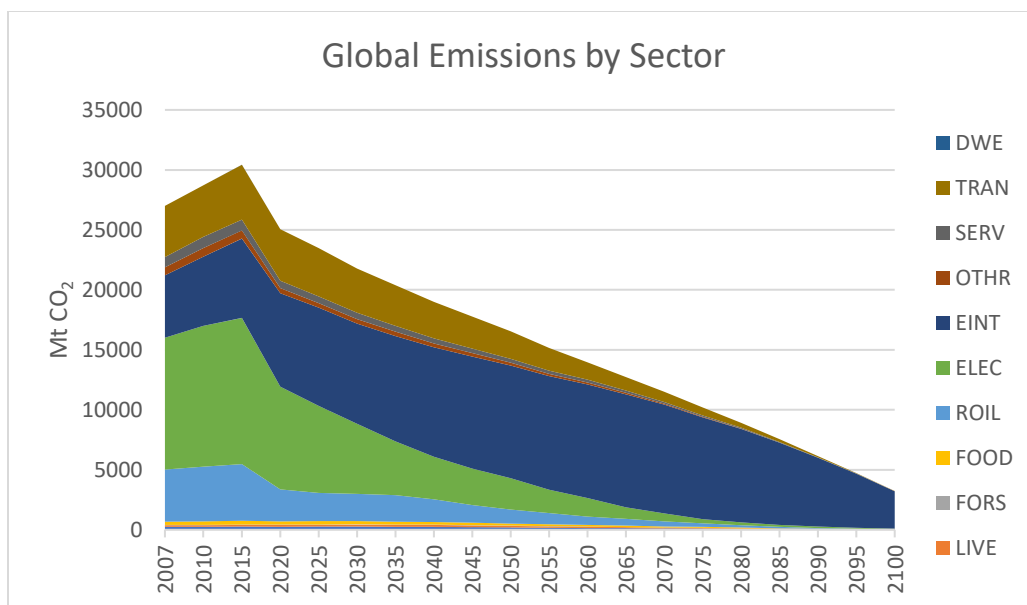

Figure 35. Global emissions by sector under a 2C Policy without industrial CCS.

Regionally, EINT emissions in the United States, Europe, India, and China decline between 2010 and 2100 by 7.9%, 32.1%, 57.7%, and 57.6%, respectively. **Figure 36** shows the emissions by sector in the United States, Europe, China, and India.

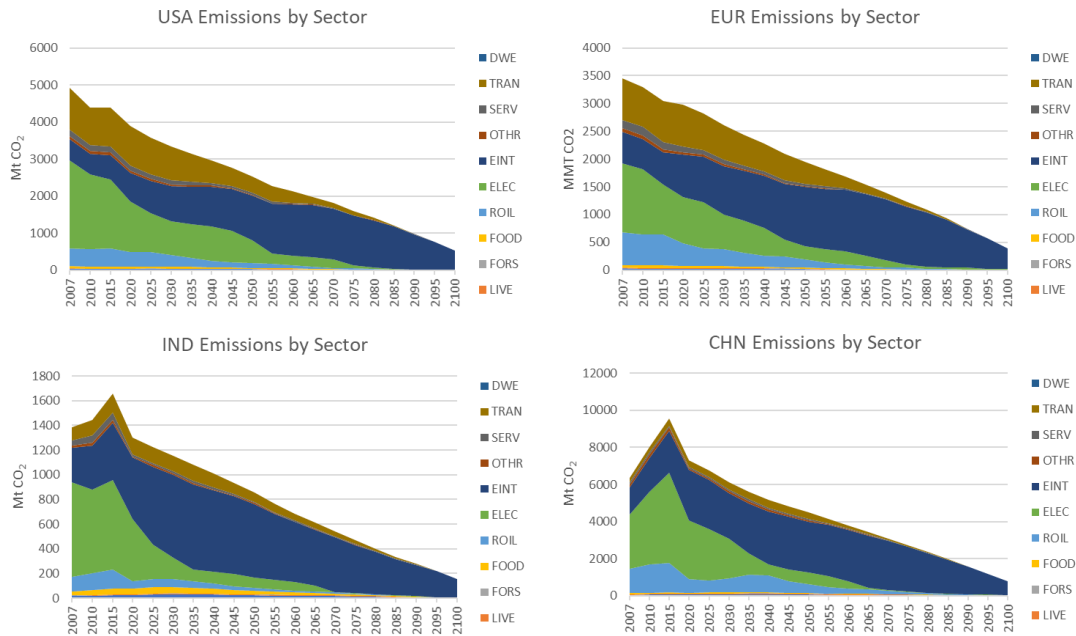

Figure 36. Regional CO₂ emissions under a 2C Policy without industrial CCS.

iii. *Policy with Industrial CCS – Cryogenic Carbon Capture*

In this scenario, an alternative to the industrial sector was introduced. Cryogenic Carbon Capture (CCC) technology, which primarily uses electricity, was provided as an alternative to the regular EINT sector. Then, depending on the carbon price imposed on CO₂ emissions and the costs of fuel inputs, each region can instead produce EINT using the CCC technology. **Figure 37** shows the estimated EINT production in a 2C scenario with CCC as an emission mitigation option. Total EINT production is maximized in 2100 at approximately 6.59 times the 2010 EINT production—still less production than in the reference case, but significantly more production than in the policy case without a CCS option.

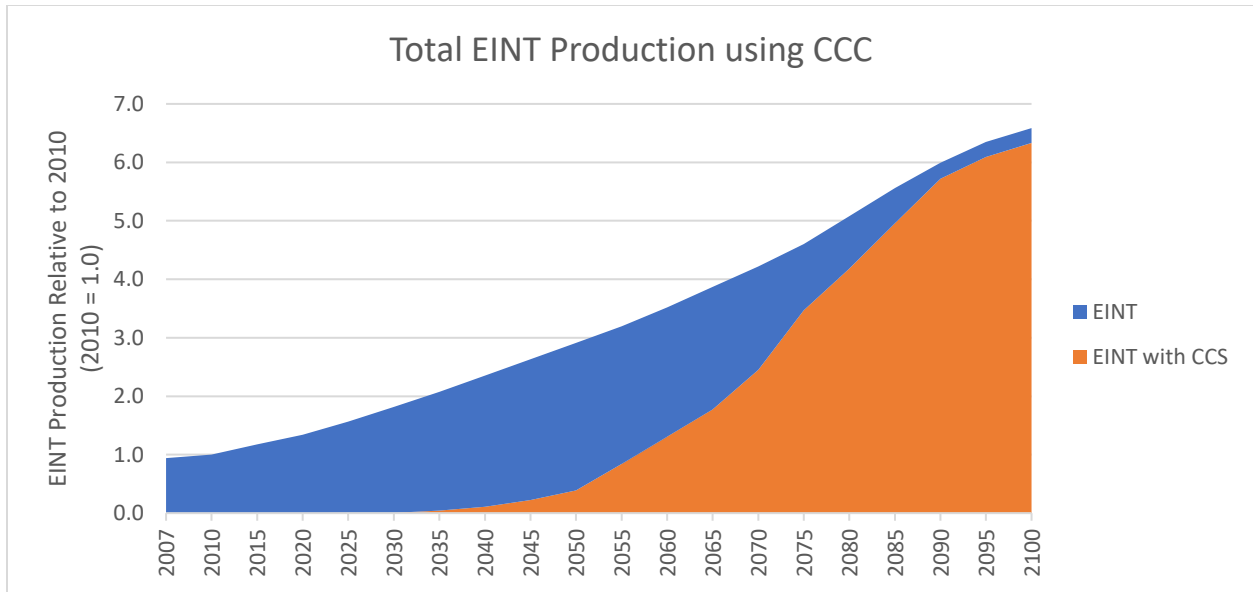

Figure 37. Total EINT Production using CCC in a 2C Policy.

In this scenario, EINT with CCC enters the world economy in 2030, and by the end of the century, comprises 100% of all new EINT production. EINT with CCC enters all 18 regions, with the largest production in China, Europe, and the United States. **Figure 38** shows the regional breakdown of EINT with CCC.

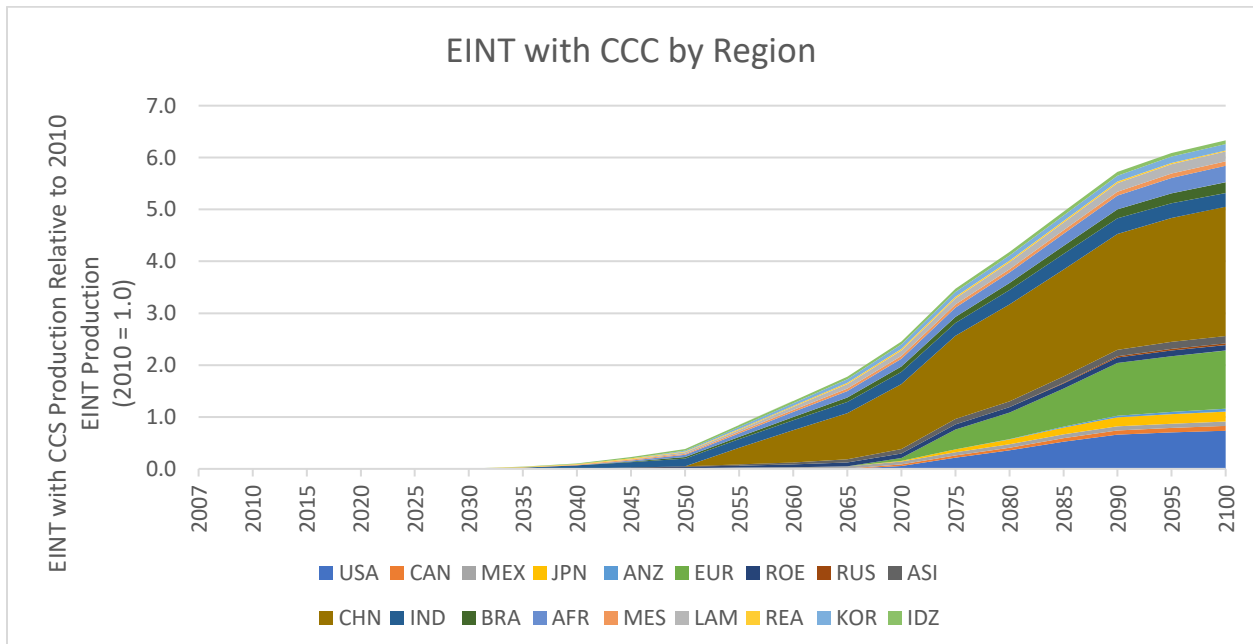

Figure 38. Regional EINT with CCC production with CCC in a 2C Policy.

At its emissions peak in 2035, the industrial sector emitted approximately 8,448 million metric tons of CO₂. From 2010 to 2100, 102,108 million metric tons of CO₂ were emitted from the EINT sector, a 66% reduction in cumulative EINT emissions relative to the reference scenario. In 2100, 75% of emissions from the EINT sector originated from a plant with CCC. With the availability of CCC in EPPA, global emissions relative to 2010 levels are reduced by 93.1% by 2100. In total, emissions in 2100 sum to 1,986 million metric tons of CO₂. EINT emissions fall 86.7% relative to 2010 levels, while emissions from electricity and transportation decrease by 96.5% and 90.9%, respectively. By the end of the century, emissions from the industrial sector made up 38.6% of all emissions in the world economy. **Figure 39** shows the global emissions by sector.

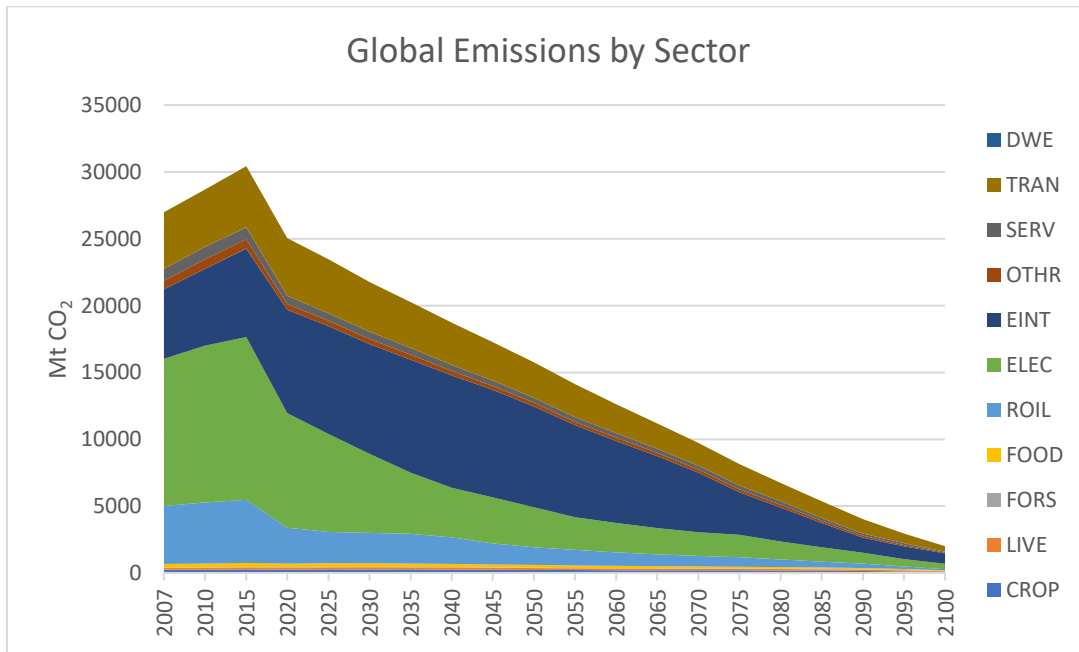

Figure 39. Global emissions by sector with CCC in a 2C Policy.

Emissions in the United States, Europe, India, and China decline in all sectors through 2100. In the United States, Europe, India, and China, emissions from the EINT sector fell by 87.0%, 78.3%, 83.8%, and 89.9%, respectively. **Figure 40** shows the emissions by sector in the United States, Europe, China, and India.

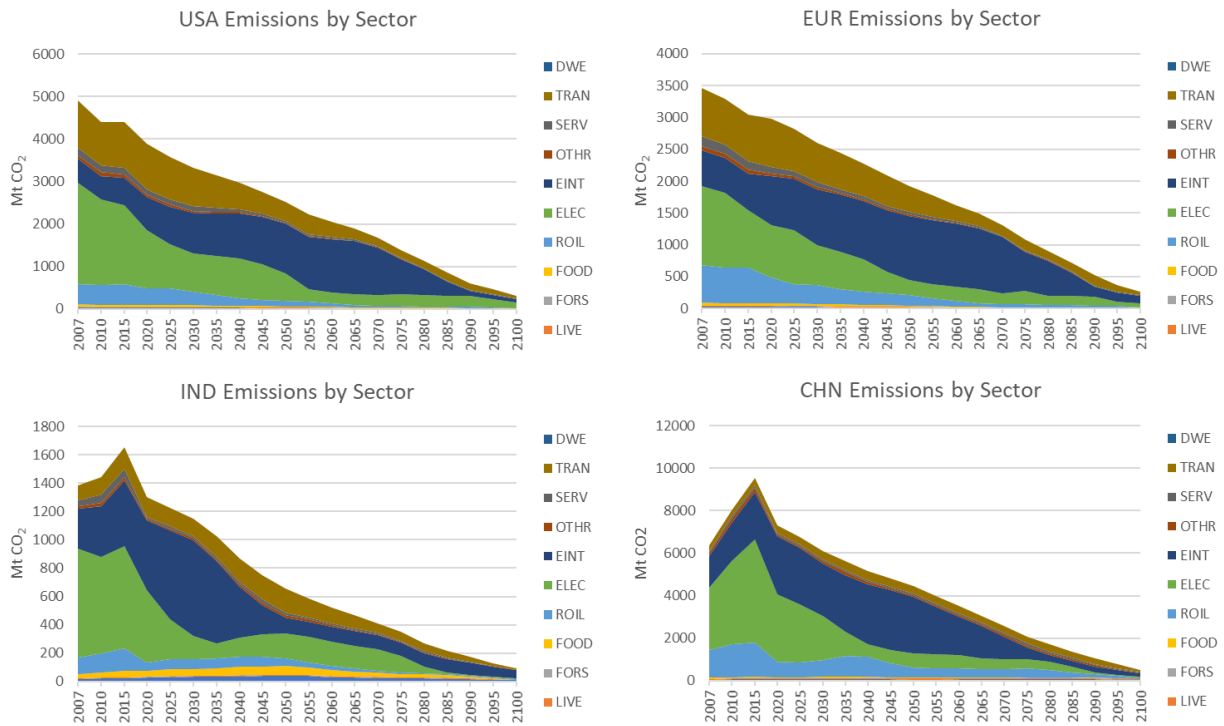

Figure 40. Regional emissions by sector with CCC in a 2C Policy.

As shown above, each region's EINT emissions reflect when the region switched from regular EINT to EINT with CCS. For example, in India by 2040, industrial plants without CCC were no longer being constructed; the region had completely switched to CCC. The United States continued to produce industrial plants without CCS until 2075, when they switched over to CCC.

iv. *Policy with Industrial CCS – Coal-fired Post Combustion Capture*

In this scenario, coal-fired PCC was inputted into the model as a technological alternative to a regular industrial plant. With a markup of 1.94 in the United States, coal-fired PCC uses larger inputs of coal than a traditional plant. **Figure 41** shows the estimated EINT production in a 2C scenario with coal-fired PCC as an emission mitigation option. Total EINT production is maximized in 2100 at approximately 3.86 times the 2010 EINT production, significantly lower than the reference scenario and also lower than the policy scenario with CCC.

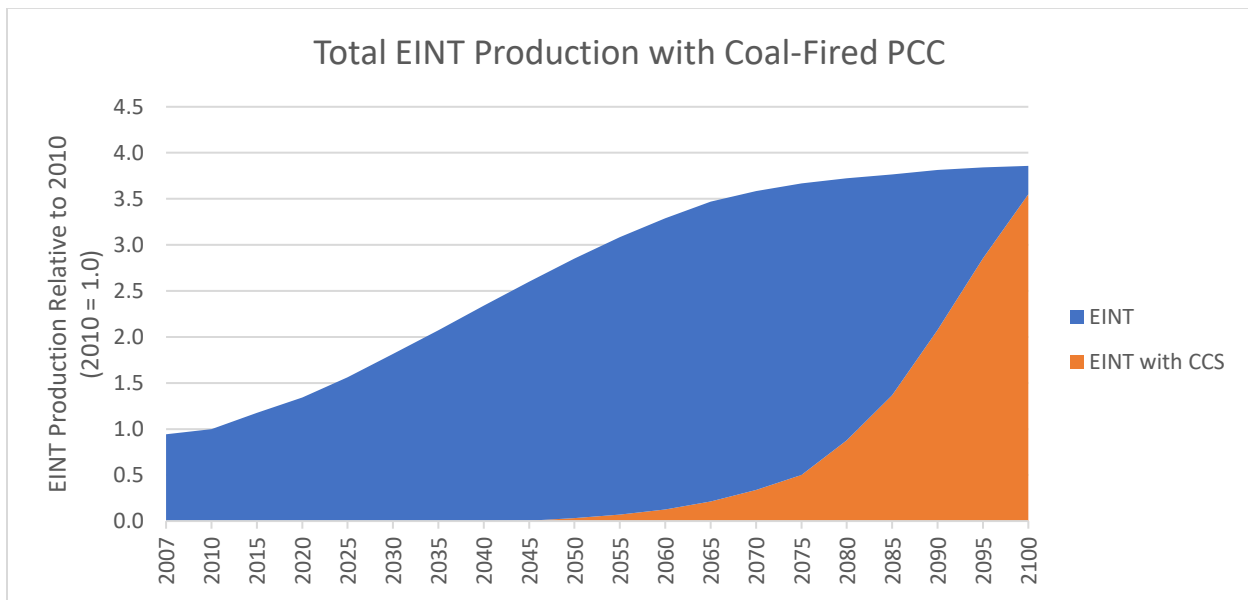

Figure 41. Total EINT Production with coal-fired PCC in a 2C Policy.

In this scenario, EINT with coal-fired PCC enters the world economy in 2040, and by the end of the century, comprises 99.9% of all new EINT production. EINT with coal-fired PCC enters all 18 regions, with the largest production in China, Europe, and the United States. **Figure 42** shows the regional breakdown of EINT with coal-fired PCC.

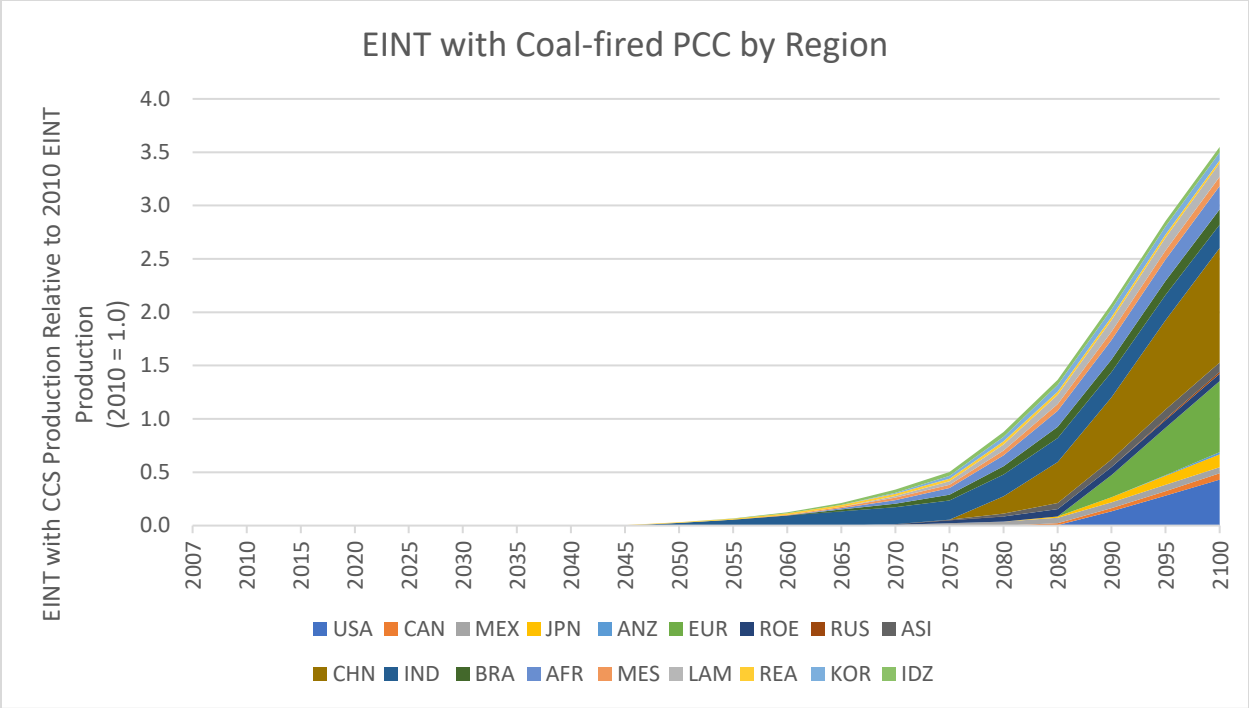

Figure 42. Regional EINT with CCS with coal-fired PCC in a 2C Policy.

At its peak in 2045, the industrial sector emitted approximately 9,291 million metric tons of CO₂. From 2010 to 2100, 139,209 million metric tons of CO₂ were emitted from the EINT sector. In 2100, 77% of emissions from the EINT sector originated from industrial plants with coal-fired PCC. With the availability of coal-fired PCC in EPPA, global CO₂ emissions relative to 2010 levels are reduced by 90.1%. In total, CO₂ emissions in 2100 sum to 2,845 million metric tons of CO₂. EINT emissions decrease by 61.4% relative to 2010 levels, while emissions from electricity and transportation decrease by 99.2% and 93.4%, respectively. By the end of the century, emissions from the industrial sector make up 78.0% of all emissions in the world economy. **Figure 43** shows the global emissions by sector.

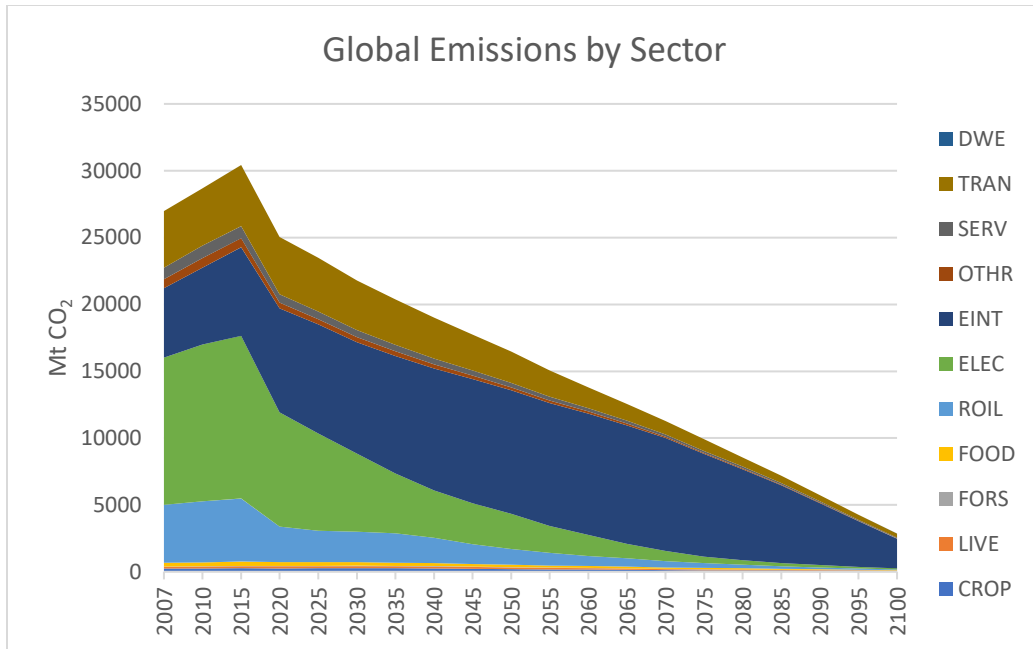

Figure 43. Global Emissions by Sector with coal-fired PCC in a 2C Policy.

EINT emissions in the United States, Europe, India, and China decline through 2100—by 32.4%, 51.6%, 85.7%, and 63.4% respectively. **Figure 44** shows the emissions by sector in the United States, Europe, China, and India.

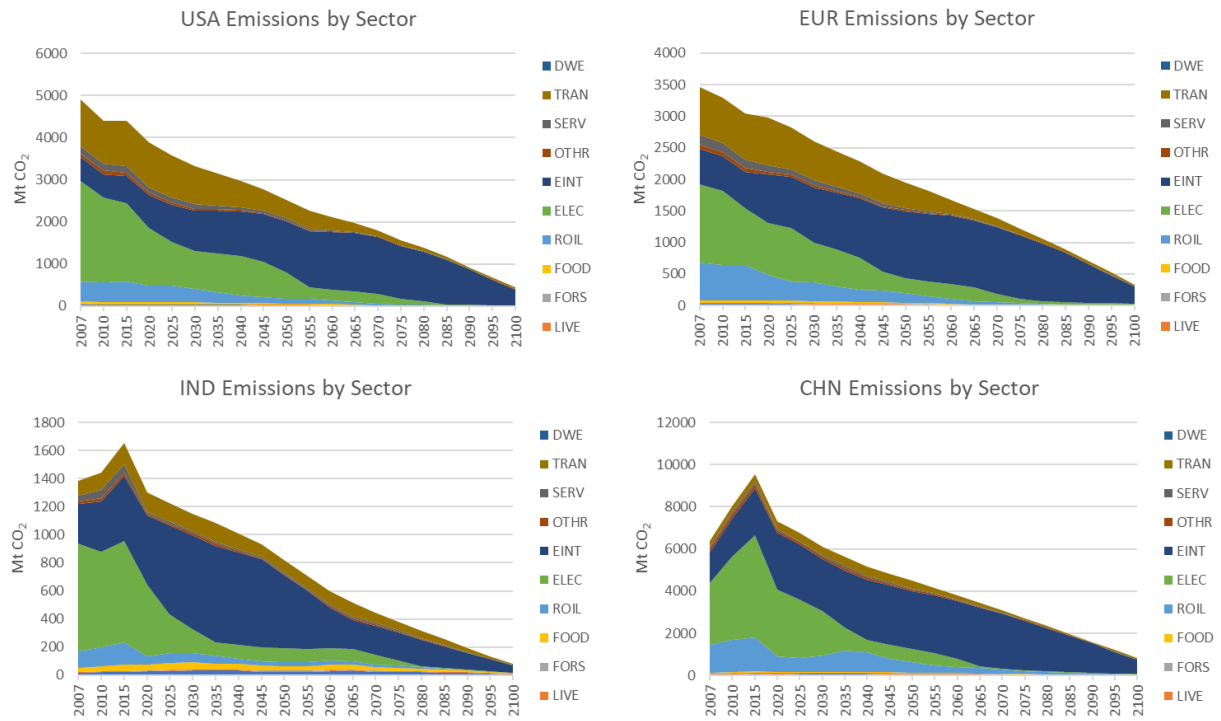

Figure 44. Regional emissions with coal-fired PCC in a 2C Policy.

As shown above, each region's EINT emissions reflect when the region switched from regular EINT to EINT with coal-fired PCC. For example, in India by 2060, industrial plants without coal-fired PCC were no longer being constructed; the region had completely switched to coal-fired PCC. The United States stopped producing industrial plants without coal-fired PCC in 2100, similarly to Europe and China.

v. *Policy with Industrial CCS – Natural Gas-fired Post Combustion Capture*

In this scenario, natural gas-fired PCC was inputted into the model as a technological alternative to a regular industrial plant. With a markup of 1.85 in the United States, natural gas-fired PCC uses larger inputs of natural gas than a traditional plant. **Figure 45** shows the estimated EINT production in a 2C scenario with natural gas-fired PCC as an emission mitigation option. Total EINT production is maximized in 2080 at approximately 3.72 times the 2010 EINT production, which again is significantly lower than in the reference scenario as well as in the policy scenario with CCC.

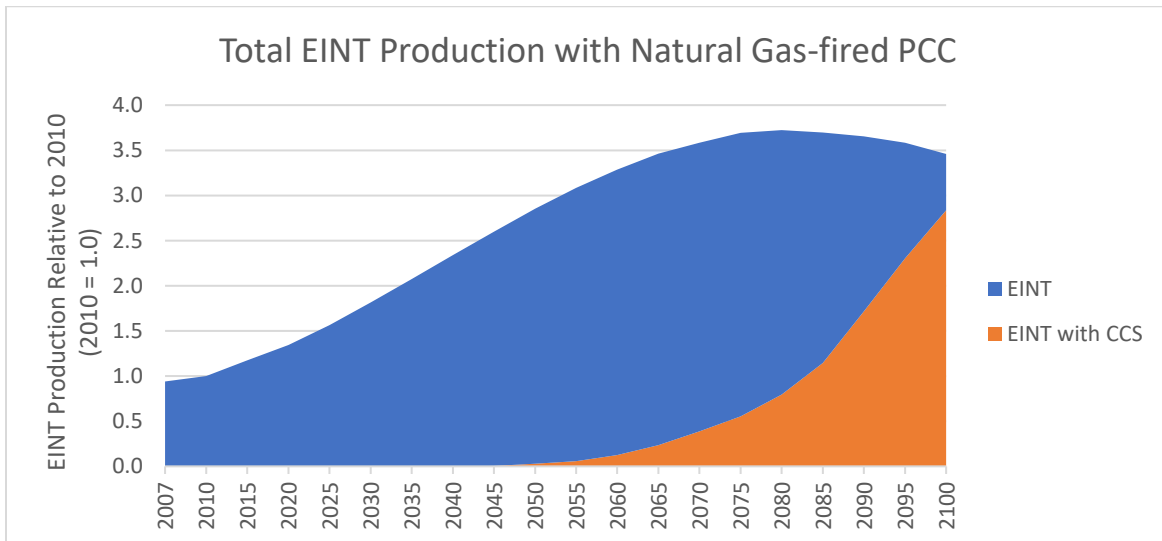

Figure 45. Total EINT production with natural gas-fired PCC in a 2C Policy.

In this scenario, EINT with natural gas-fired PCC enters the world economy in 2035, and by the end of the century, comprises 87.0% of all new EINT production. EINT with natural gas-fired PCC enters 17 regions, with the largest production in Europe, the United States, and Africa. Natural gas-fired PCC does not enter the China (CHN) region at any time, driven by the high

natural gas prices in China. **Figure 46** shows the regional breakdown of EINT with natural gas-fired PCC.

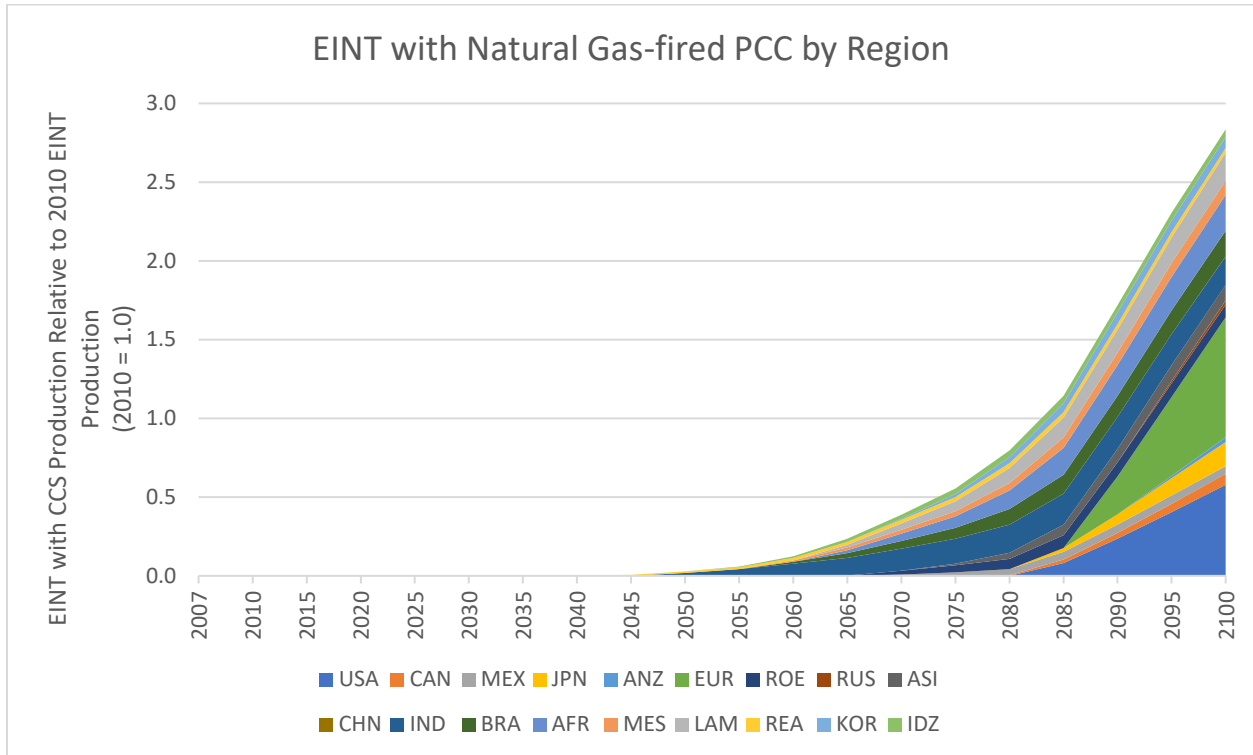

Figure 46. Regional EINT with CCS production with natural gas-fired PCC in a 2C Policy.

At its emissions peak in 2045, the industrial sector emitted approximately 9,270 million metric tons of CO₂. From 2010 to 2100, 139,011 million metric tons of CO₂ were emitted from the EINT sector. In 2100, 55% of emissions from the EINT sector originated from industrial plants with natural gas-fired PCC. With the availability of natural gas-fired PCC in EPPA, global emissions in 2100 were reduced by 90.0% relative to 2010 levels. In total, emissions in 2100 sum to 2,859 million metric tons of CO₂. EINT emissions fall by 58.9% relative to 2010 levels, while emissions from electricity and transportation decrease by 99.1% and 95.3%, respectively. By the end of the century, emissions from the industrial sector make up 82.8% of all emissions in the world economy. **Figure 47** shows the global emissions by sector.

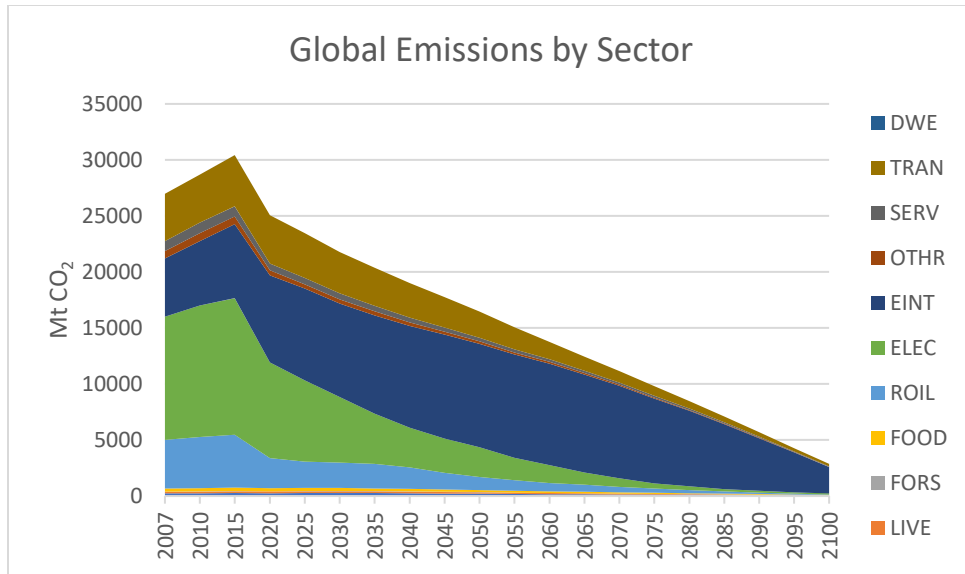

Figure 47. Global Emissions by Sector with natural gas-fired PCC in a 2C Policy.

EINT emissions in the United States, Europe, India, and China decline through 2100—by 36.1%, 47.4%, 83.7%, and 59.7%, respectively. Though China did not adopt natural gas-fired PCC technology, it did significantly cut its EINT production between 2080 and 2100. **Figure 48** shows the emissions by sector in the United States, Europe, China, and India.

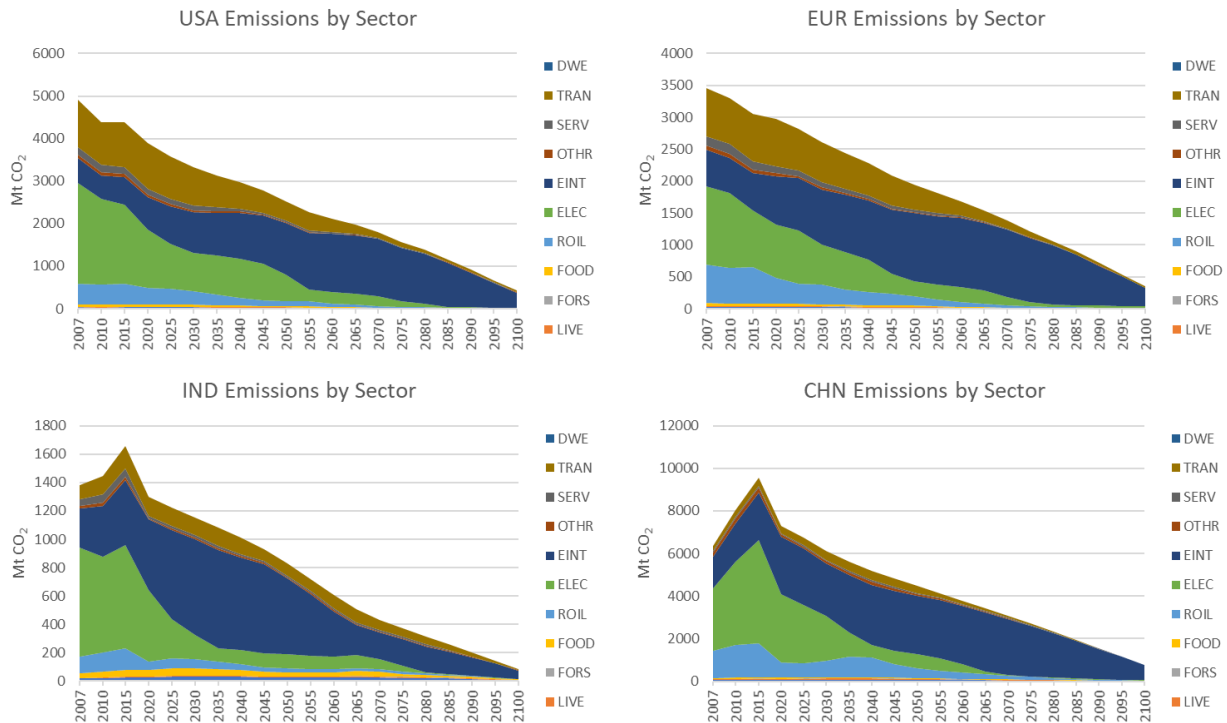

Figure 48. Regional sectoral emissions with natural gas-fired PCC in a 2C Policy.

As shown above, each region's EINT emissions reflect when the region switched from regular EINT to EINT with natural gas-fired PCC. For example, India began producing natural gas-fired PCC plants in 2050, while the United States did not begin producing CCS plants until 2085. Natural gas-fired CCS was never introduced into China, even at the end of the century, but production of EINT was maximized in 2070 and then fell by 63% by 2100.

VIII. Discussion and Sensitivity Analyses

The emissions in each sector varied based on the type of technology introduced. When industrial CCS is not introduced in the world economy, there are no viable emission mitigation options available for industrial production. Therefore, in order to reach its emissions targets, each region was forced to significantly limit the growth of industrial production as well as reduce additional emissions in other sectors. In the policy case without CCS, by 2100 regions reduced total non-EINT emissions by 99.6% relative to 2010 levels. However, EINT emissions were only reduced by 45.7%, which was accompanied by stagnation and decline in EINT production by the end of the century.

When CCC was introduced, by 2100 total non-EINT emissions were reduced by only 94.7% relative to 2010 levels – a 4.9% decrease compared to the policy case without industrial CCS. This decrease occurs because when CCC was introduced, the EINT sector emissions were reduced by 86.7%, allowing for less stringent reductions in other sectors. For example, in a policy scenario without industrial CCS, emissions in the transportation sector were reduced by 99.9% overall, but when CCC, coal-fired, and natural gas-fired CCS technologies were available, emissions in the transportation sector were reduced by 90.9%, 93.4%, and 95.3%, respectively. Using CCC, emissions in the electricity sector were decreased by only 96.5%, while electricity emissions were reduced by over 99% when only PCC was available. Overall, the global economy reached the most emissions reductions with the availability of CCC, with total CO₂ emissions reduced by approximately 93.1% in 2100. **Table 29** shows the sectoral and total emission reductions under each policy scenario. As shown, when industrial CCS is not available, large cuts are made in almost every economic sector.

Table 29. Percent change in emissions by sector from 2010 to 2100 with each policy case, including policy without industrial CCS, with CCC, with Coal-fired PCC, and Natural Gas-fired PCC.

		% Reduction in Emissions in 2100 relative to 2010			
	% of 2010 Emissions	No CCS	CCC	Coal-Fired PCC	Natural Gas-fired PCC
CROP	1%	97%	67%	79%	84%
LIVE	<1%	91%	57%	74%	80%
FORS	<1%	94%	39%	74%	80%
FOOD	1%	99%	82%	87%	91%
ROIL	16%	100%	98%	99%	99%
ELEC	45%	100%	96%	99%	99%
EINT	19%	40%	85%	57%	54%
OTHR	2%	100%	91%	96%	98%
SERV	3%	100%	91%	93%	95%
TRAN	12%	100%	91%	93%	95%
DWE	<1%	100%	80%	83%	96%
Total		88%	93%	89%	89%

In addition to emissions varying based on the technology available, global welfare is also impacted by the availability and cost of CCS. As shown in **Figure 49**, global consumption varies depending on which industrial CCS technology is introduced. Without CCS, global consumption peaks in 2080 at \$121 trillion and falls to \$52 trillion by the end of the century. This is largely driven by the decrease in production of the energy intensive sector. In each policy case with CCS, the global consumption was higher than without CCS, with eventual declines in consumption using coal-fired PCC beginning in 2090 and using natural gas-fired PCC beginning in 2085. The consumption was the greatest with the introduction of the CCC technology, which had the lowest markup over the traditional EINT sector. Again, this is largely driven by production in the EINT sector. With CCC, industrial production is able to continue to rise throughout the century, while also significantly reducing emissions from the sector. Compared to the reference scenario, in 2100

the policy scenario with CCC decreases industrial production by only 18% while reducing industrial sector emissions by 85%. With the more expensive coal and natural gas PCC, this effect is also present, but at a lower level.

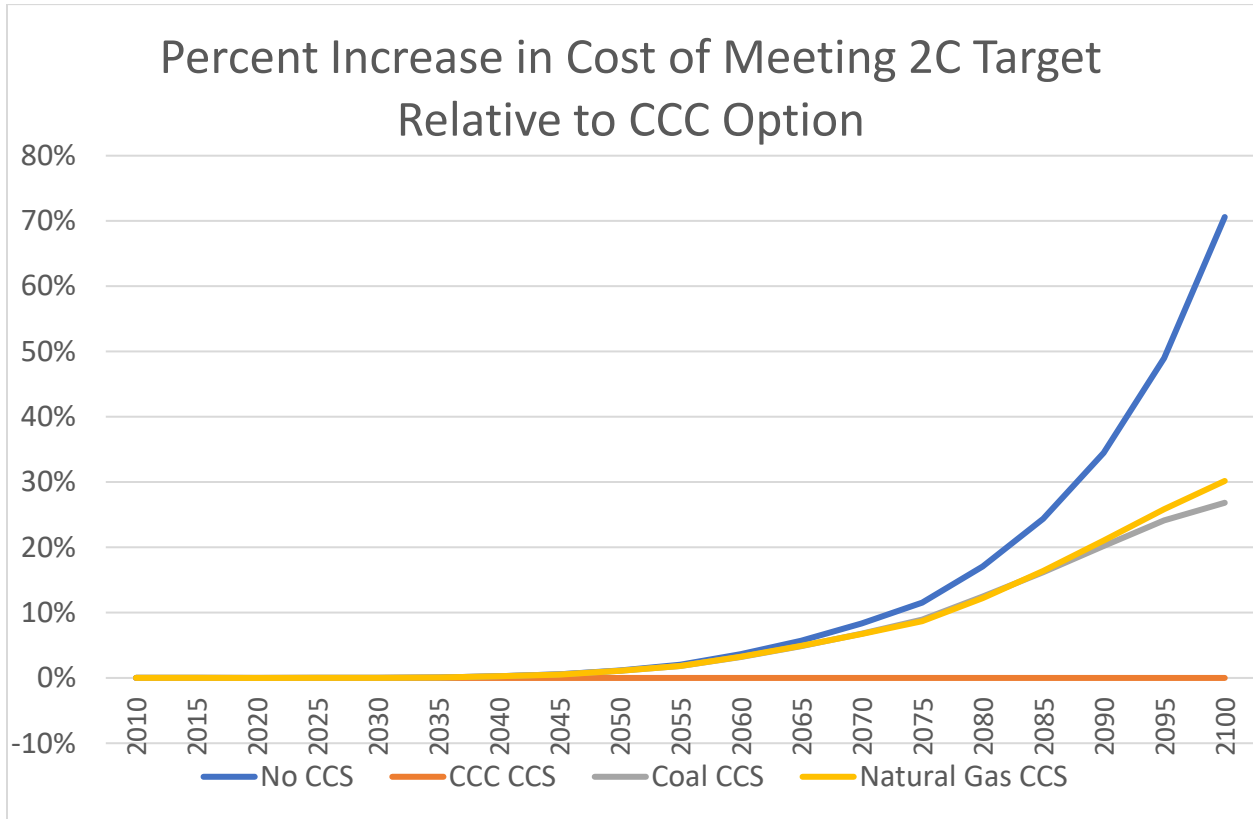

Figure 49. Percent Increase in Cost of Meeting 2C Target Relative to the CCC Option

i. Sensitivity – Lower Cost of CCS

In order to estimate the potential of lower-cost industrial CCS in the world economy, a sensitivity was run where the percent markup was halved for the PCC technologies. Since electricity is generated in the IEAGHG (2013) and Barker et al. (2009) studies, this analysis can be used to estimate the competitiveness of coal-fired and natural gas-fired PCC should they generate electricity sales. The markup for the coal-fired PCC unit was lowered from 1.95 to 1.47

and the new markup for the natural gas-fired PCC technology was lowered from 1.85 to 1.43. The ratio of CCS input shares remained the same, but were scaled to match the new markups.

Figure 50 shows the difference in EINT production in coal-fired and natural gas-fired PCC with regular and reduced markups. In each policy scenario, the CCS technology had greater penetration across regions. For example, lowering the cost of coal-fired PCC allowed the technology to enter China in 2065 instead of entering in 2080. Lowering the cost of natural gas-fired PCC, however, still did not allow the technology to enter into China (again, driven by the high natural gas prices in China).

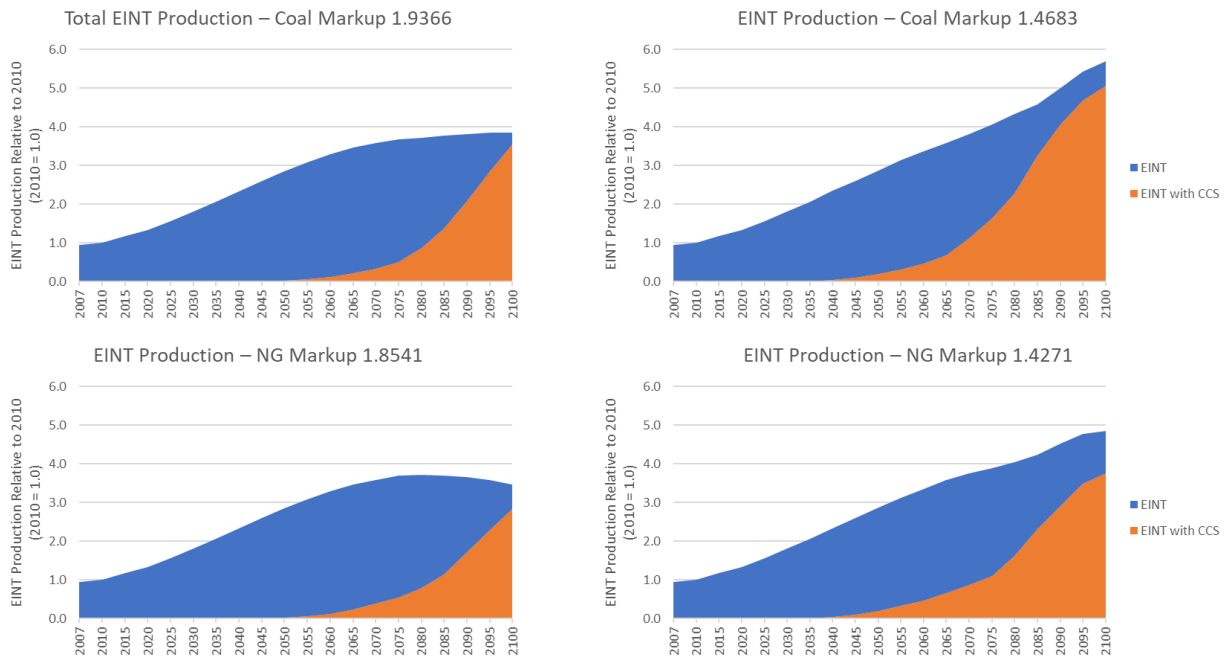

Figure 50. Global EINT production using regularly priced and reduced price coal- and natural-gas fired PCC. (Top row, coal PCC with a markup of 1.9366 [base], coal PCC with a markup of 1.4683; bottom row, natural gas PCC with a markup of 1.8541 [base], natural gas PCC with a markup of 1.4271)

In addition to increased production of EINT and CCS, lowering the markup of the two PCC technologies also decreased the amount of emissions in both the EINT sector and in the overall economy. Further, lowering the markup increased the consumption of the global economy, as shown in **Table 30**. With lower costs of coal-fired PCC, there were actually *increases* in emissions in the transportation and electricity sector, which were then offset by the large decrease in emissions from the EINT sector. Global consumption rose 20.3% with the lower cost coal-fired PCC. It is likely that with lower costs for the coal-fired PCC, regions decided to make larger, cheaper cuts in the EINT sector than more expensive emissions reductions in the transportation and electricity sector.

Table 30. Emissions, CCS construction, and consumption varying by cost of technology

	CCC	Base Coal	Cheap Coal	% Change	Base NG	Cheap NG	% Change
2100 EINT Emissions (million metric tons)	766	2219	1900	-14.4%	2367	2097	-11.4%
2100 Total Emissions (million metric tons)	1986	2845	2672	-6.1%	2859	2692	-5.8%
Percent New Build Being CCS	100.0%	99.9%	100.0%	0.1%	87.0%	92.7%	6.6%
2100 Consumption (trillion US\$)	176.2	128.9	155.1	20.3%	123.0	144.2	17.2%

ii. *Sensitivity – No Emissions Trading Allowed*

In the base runs of the model, international emissions trading for greenhouse gases is allowed. Here I explore how the results change if international emissions trading is not allowed — each region is responsible for making emissions cuts themselves. Regions can reduce their emissions through efficiency improvements, new technologies, fuel switching, or reduced production. If emissions trading is allowed, some regions can reduce additional emissions at lower

costs, while other regions with higher costs can trade emissions permits to still meet their emission targets. **Figure 51** shows the difference in EINT production with and without emissions trading, using coal-fired PCC.

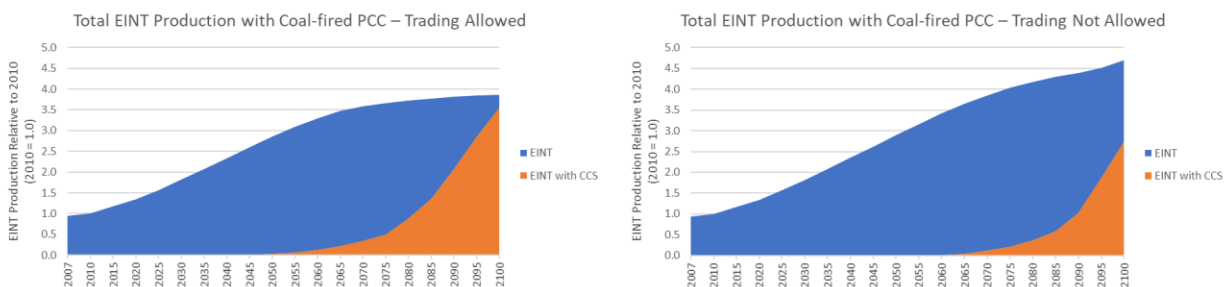

Figure 51. Total EINT production with coal-fired PCC with trading allowed and with trading not allowed.

When emissions trading is allowed, the total amount of energy intensive goods produced in 2100 is 3.86 times larger than 2010 EINT production, and when international emissions trading is not allowed, the total amount of industrial CCS produced in 2100 is 4.70 times larger than 2010 EINT production. However, there is a greater amount of EINT produced from coal-fired PCC units when trading is allowed: there is 3.55 times the amount of 2010 production when trading is allowed, and only 2.74 times the amount of 2010 production when trading is not allowed. Therefore, emissions trading can significantly impact the amount of industrial CCS that enters the world economy, along with the total amount of EINT production.

In addition to production levels, there are differences in how soon each region adopts the new technology and how quickly it increases its production. In some regions, allowing for trading brought industrial CCS sooner, while in other regions, industrial CCS entered the model sooner when trading was not allowed. In addition, the maximum amount of coal-fired PCC produced varies significantly depending on whether emissions trading is allowed. As shown in **Table 31**,

the production of industrial CCS was maximized in the regions of Mexico, Australia-New Zealand, Rest of Europe, Russia, Asia, Rest of Asia, Korea, and Indonesia without trading. Meanwhile, the remaining regions had larger single-year maxima with trading. China, when allowed trading, increased its production of coal-fired PCC by almost 10-fold, suggesting China would be a major seller of emissions permits if trading is allowed.

Table 31. Differences in the year CCS enters each region and the maximum amount of EINT with CCS production, depending on whether trading is prohibited or allowed.

	Without Trade	With Trade	Without Trade	With Trade
	Year Entered		Maximum Amount	
USA	2090	2085	0.384	0.431
CAN	2085	2085	0.042	0.059
MEX	2075	2070	0.063	0.058
JPN	2085	2085	0.119	0.121
ANZ	2090	2095	0.478	0.021
EUR	2075	2090	0.085	0.665
ROE	2080	2070	0.095	0.074
RUS	2090	2095	0.568	0.020
ASI	2060	2075	0.373	0.087
CHN	2085	2080	0.128	1.073
IND	2095	2050	0.046	0.237
BRA	2065	2060	0.046	0.143
AFR	2080	2065	0.103	0.219
MES	2055	2060	0.060	0.086
LAM	2070	2070	0.081	0.129
REA	2065	2040	0.066	0.030
KOR	2055	2070	0.110	0.076
IDZ	2055	2055	0.089	0.051

Because the total amount of coal-fired PCC production varied significantly, the total amount of emissions reduced also varied. Without trading, 2100 global EINT emissions only decreased 15.0% relative to 2010 levels. When allowing emissions trading, 2100 global EINT emissions decreased 61.4% relative to 2010 levels. In addition, by allowing for trading, both the electricity and transportation sectors were able to significantly reduce their emissions globally. For

example, in the electricity sector, emissions were reduced by 98.5% without trading and were reduced by 99.2% with trading. Global transportation emissions without trading decreased by 86.1%, while they decreased by 93.4% when allowing for trading.

iii. Sensitivity – Alternative Emission Targets

In the policy scenario ran above, quantity targets were used to keep total global CO₂-equivalent emissions at approximately 495,735 million metric tons. To more closely resemble 2C targets based on a 66% probability of limiting warming to 2C, quantity targets were used that produce 527,975 million metric tons of emissions. Therefore, in this case, there is a less stringent quantity restriction on the total amount of CO₂. In this case, each region was given specific quantity targets that depended on each region's individualized emission reduction profile.¹² With these individualized targets, some regions were required to reduce emissions more quickly than under the original quantity targets, such as Russia and Australia-New Zealand. In other regions, such as in India, Rest of Asia, Europe, and Latin America, the new quantity targets allowed for larger emissions for a longer period of time than with the original emissions targets. In some regions, including in the United States, Canada, Japan, Australia-New Zealand, Russia, and Asia, the 2100 emissions targets using the new values are lower than in the base emissions targets. In several other regions, however, including Europe, Africa, and India, the new targets in 2100 are higher than the base targets, allowing for greater emissions by the end of the century. **Figure 52** shows the regional CCC production under both the base quantity targets and the new quantity targets.

¹² These quantity targets were created based on previous EPPA modeling where the carbon price was fixed and each region individually reduced emissions based on the carbon tax.

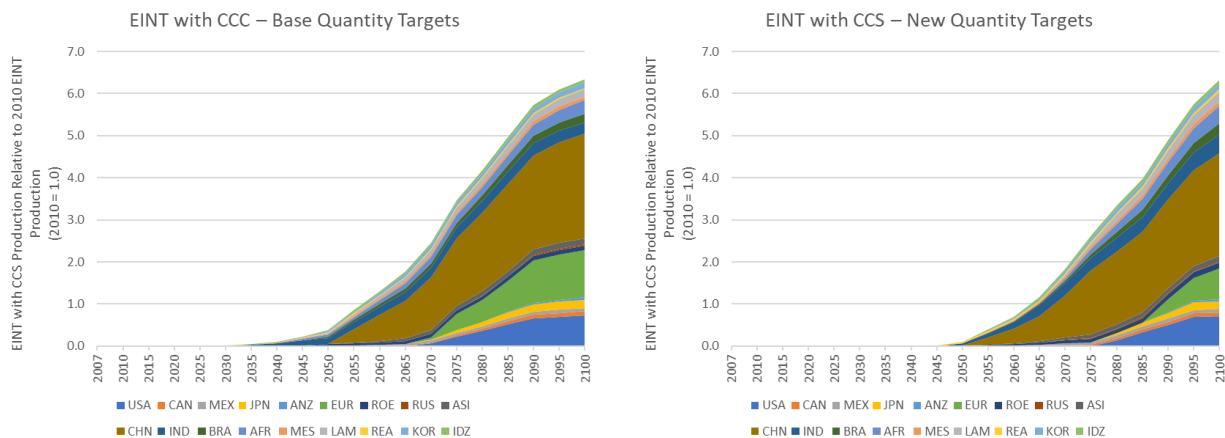

Figure 52. Regional EINT with CCS production using base quantity emissions targets and new quantity emissions targets.

While China remains the largest producer of EINT with CCC, because the emission targets are very similar, there is not a large difference in CCC adoption. However, because the 2100 target for Europe increased from 0.10 to 0.31, the emission target is less stringent, and there is less industrial CCS overall. Overall, using these emissions targets, total emissions declined by 85.7%, while emissions from the EINT sector only declined by 78.8% relative to 2010 levels. Using base settings, total sectoral CO₂ emissions declined by 93.1%, with emissions from the EINT sector declining by 86.7% relative to 2010 levels. As expected, the stringency and time path of emissions reduction targets will impacts the timing and level of industrial CCS.

IX. Conclusion

This thesis offers several contributions to the existing literature on industrial CCS. First, I conducted a literature review comparing several CCS technologies that can be applied to a cement plant. Each study provided unique technological details and costs of CCS technologies. In order to compare cement with CCS technologies directly, I created a methodology by standardizing the costs and inputs of CCS units and adding them to the costs and inputs of cement plants. Using this methodology, cost inputs of capital, O&M, fuels, and electricity could be directly compared. Then, these inputs were used to estimate the emissions created from the CCS unit, and the total cost of production of cement was found. Modeled after the Levelized Cost of Electricity calculation in the power sector, this metric allows cement plants with and without CCS to be directly compared to each other, irrespective of production capacity.

Using this methodology, the costs of a cement plant with CCS were compared directly to a reference plant without CCS using both a markup and cost shares. Using these inputs, I created a separate new production block of energy-intensive goods with CCS in an energy-economic model and evaluated the competitiveness of industrial CCS in a global economy with a carbon policy. While the MIT EPPA model was used for this study, these inputs could be similarly used in a different energy-economic model.

I then analyzed the impact of industrial CCS on total industrial production, global, sectoral and regional emissions, and global welfare. The availability of industrial CCS in a 2C policy allowed for a significant increase in the production of energy intensive goods relative to a 2C policy without the availability of industrial CCS. Without CCS, 2100 industrial production was only 1.56 times 2010 levels, while with coal-fired post-combustion capture (PCC), natural gas-fired PCC, and Cryogenic Carbon Capture (CCC) 2100 production was 3.86, 3.46, and 6.98 times 2010 levels,

respectively. With CCC capture, total production from the EINT sector is only reduced by 18.2%, relative to production in the reference case, while production without CCS is reduced by 80.6%, relative to the reference case production.

I also found that industrial CCS, under a 2C policy, has the potential to reduce global CO₂ emissions by an additional 5% by 2100 relative to a policy scenario without industrial CCS. The availability of industrial CCS significantly decreased the emissions in the industrial sector relative to the policy scenario without industrial CCS, with reductions in 2100 of 14%, 17%, and 45% using coal-fired PCC, natural gas-fired PCC, and CCC, respectively, relative to a 2C policy without industrial CCS. Without industrial CCS, the costs of reaching the 2C emissions target increase by 12% in 2075 and 71% in 2100 relative to the cost of achieving the policy with CCC. Overall, industrial CCS allows for the continued consumption of energy-intensive goods with large reductions in global and sectoral emissions.

This research also analyzed the competitiveness of several types of CCS technologies in a global economic model. Coal-fired PCC, natural gas-fired PCC, and CCC were each separately evaluated in EPPA with their specific costs and inputs. CCC was the most competitive CCS technology, as its costs were only 24% greater than the costs of a reference cement plant in the United States. The lower costs of the CCC process are primarily due to the process not requiring steam from an on-site boiler. Coal-fired PCC also showed promise in several regions, despite being 94% more expensive than a traditional cement plant in the United States. Natural gas-fired PCC, while being cheaper than coal-fired PCC, was not as competitive under a 2C scenario, primarily because of its failure to replace traditional plants in China. Should costs decrease, CCS technology will become increasingly competitive. In addition to these findings, several other factors were investigated, including the ability to sell electricity as a by-product of steam production (by

lowering overall costs), the ability to trade emission permits internationally, and with an alternative emission targets. Each of these sensitivities impacted the timing and level of industrial CCS production.

While the methodology I created shows detailed estimates of costs and inputs, the economic model I used requires only aggregated inputs of technologies. Because of this, more detailed information regarding each technology is lost. The methodology I produced can be replicated for a more detailed engineering model, which could more precisely detail the inputs of the CCS technologies. In addition, because of the relative infancy of industrial CCS, the cost estimates used in this analysis are likely to change in the future given technological improvements. This thesis provides a common methodology to analyze new cement with CCS technologies. In addition, while cement was the primary focus of this analysis, this approach can be applied to other industrial sectors to determine the competitiveness of various technologies.

Appendix A. Fuel Conversion from Biomass and Petroleum Coke to Coal Inputs

In several of the cement plants referenced, biomass and petroleum coke were cited as inputs to the combustion process. While the costs and carbon contents of these materials vary significantly, in order to simplify the calculations of fuel inputs, inputs of biomass and petroleum coke were converted to heating values, and then converted into inputs of coal for simplification. The heating values for each of these fuels was obtained from the EPA (EPA, 2014) The following was assumed for this calculation:

	Energy Content of Fuel	Conversion to Coal
Coal	29.0 mmBTU/ t coal	-
Biomass	11.0 mmBTU/ t biomass	0.379 t coal/ t biomass
Petroleum Coke	33.1 mmBTU/ t petroleum coke	1.142 t coal/ t petroleum coke

Table 32.

For example, in the IEAGHG (2013) reference case, the inputs for the cement plant were 70,720 metric tons of coal per year along with 54,400 metric tons of biomass per year. By converting the biomass to coal, the biomass inputs are approximately equal to 20,497 metric tons of coal. Thus, in total, the input for the cement plant was approximately 91,317 metric tons of coal per year. The carbon content of coal was then applied to this aggregated value to estimate the total emissions from combustion of both coal and biomass. **Table 33** shows the calculations made to convert biomass and petroleum coke inputs to coal inputs.

	Cement w/ CCC	Cement w/ Coal CCS (IEA + Hegerland)	Cement w/ NG CCS (IEA + Hegerland)	Cement w/ NG CCS (IEA + NETL)	Cement w/ Partial Oxyfuel (IEA)	Cement w/ Oxyfuel (IEA)	Cement w/ NG CCS (IEA)	Cement w/ Coal CCS (IEA)	Reference Plant (IEA)	Cement w/ Oxy CCS (Barker)	Cement w/ Coal CCS (Barker)	Reference Plant (Barker)
Coal Input (kt/year)	71	212	80	80	71	71	71	379	71	72	292	63
Biomass Input (kt/year)	54	61	61	61	54	54	54	54	54	-	-	-
Equivalent Biomass to Coal (kt/year)	21	23	23	23	21	21	21	21	21	-	-	-
Coke Input (kt/year)	-	-	-	-	-	-	-	-	-	27	33	33
Equivalent Coke to Coal (kt/year)	-	-	-	-	-	-	-	-	-	31	38	38
Total Coal Input (kt/year)	91	235	103	103	91	91	91	400	91	103	329	101

Table 33.

Appendix B. Mapping of Countries to EPPA regions

Country	EPPA Region
Afghanistan	REA
Albania	ROE
Algeria	AFR
Angola	AFR
Argentina	LAM
Armenia	ROE
Australia	ANZ
Austria	EUR
Azerbaijan	ROE
Bahrain	MES
Bangladesh	REA
Barbados	LAM
Belarus	ROE
Belgium	EUR
Benin	AFR
Bhutan	REA
Bolivia	LAM
Bosnia and Herzegovina	ROE
Botswana	AFR
Brazil	BRA
Brunei	REA
Bulgaria	EUR
Burkina Faso	AFR
Burma	REA
Burundi	AFR
Cambodia	REA
Cameroon	AFR
Canada	CAN
Chad	AFR
Chile	LAM
China	CHN
Colombia	LAM
Congo (Brazzaville)	AFR
Congo (Kinshasa)	AFR
Costa Rica	LAM
Côte d'Ivoire	AFR
Croatia	ROE
Cuba	LAM
Cyprus	EUR

Country	EPPA Region
Czech Republic	EUR
Denmark	EUR
Djibouti	AFR
Dominican Republic	LAM
Ecuador	LAM
Egypt	AFR
El Salvador	LAM
Eritrea	AFR
Estonia	EUR
Ethiopia	AFR
Fiji	ANZ
Finland	EUR
France	EUR
French Guiana	LAM
Gabon	AFR
Georgia	ROE
Germany	EUR
Ghana	AFR
Greece	EUR
Guadeloupe	LAM
Guatemala	LAM
Guinea	AFR
Guyana	LAM
Haiti	LAM
Honduras	LAM
Hong Kong	CHN
Hungary	EUR
Iceland	ROE
India	IND
Indonesia	IDZ
Iran	MES
Iraq	MES
Ireland	EUR
Israel	MES
Italy	EUR
Jamaica	LAM
Japan	JPN
Jordan	MES
Kazakhstan	ROE
Kenya	AFR

Country	EPPA Region
Korea, North ^e	N/A
Korea, Republic of	KOR
Kosovo	ROE
Kuwait	MES
Kyrgyzstan	ROE
Laos	REA
Latvia	EUR
Lebanon	MES
Liberia	AFR
Libya	AFR
Lithuania	EUR
Luxembourg	EUR
Macedonia	ROE
Madagascar	AFR
Malawi	AFR
Malaysia	ASI
Martinique	LAM
Mauritania	AFR
Mexico	MEX
Moldova	ROE
Mongolia	REA
Morocco	AFR
Mozambique	AFR
Namibia	AFR
Nepal	REA
Netherlands	EUR
New Caledonia	ANZ
New Zealand	ANZ
Nicaragua	LAM
Niger	AFR
Nigeria	AFR
Norway	EUR
Oman	MES
Pakistan	REA
Panama	LAM
Papua New Guinea	ANZ
Paraguay	LAM
Peru	LAM
Philippines	ASI
Poland	EUR
Portugal	EUR

Country	EPPA Region
Qatar	MES
Reunion	AFR
Romania	EUR
Russia	RUS
Rwanda	AFR
Saudi Arabia	MES
Senegal	AFR
Serbia	ROE
Sierra Leone	AFR
Singapore	ASI
Slovakia	EUR
Slovenia	EUR
South Africa	AFR
Spain, including Canary Islands	EUR
Sri Lanka	REA
Sudan	AFR
Suriname	LAM
Sweden	EUR
Switzerland	EUR
Syria	MES
Taiwan	ASI
Tajikistan	REA
Tanzania	AFR
Thailand	ASI
Togo	AFR
Trinidad and Tobago	LAM
Tunisia	AFR
Turkey	ROE
Turkmenistan	REA
Uganda	AFR
Ukraine	ROE
United Arab Emirates	MES
United Kingdom	EUR
United States, including Puerto Rico	USA
Uruguay	LAM
Uzbekistan	REA
Venezuela	LAM
Vietnam	REA
Yemen	MES

Zambia	AFR
Zimbabwe	AFR

Bibliography

- Barker, D., Turner, S., Napier-Moore, P., Clark, M., & Davison, J. (2009). CO₂ Capture in the Cement Industry. *Energy Procedia*, 87-94.
- Brevik, P. (2017, November 7). *The full scale CCS-project at Norcem Brevik: can it be realized?* Retrieved from Heidelberg Cement: https://www.sintef.no/globalassets/sintef-energi/cemcap/11_full-scale_ccs-project_norcem_brevik.pdf
- Davidson, E. (2014, June). Defining the Trend: Cement Consumption versus Gross Domestic Product. *Cement Trends*, pp. 8-14. Retrieved from <http://www.globalcement.com/images/stories/documents/articles/eGC-June2014-8-12.pdf>
- DOE. (2016). *Environment Baseline, Volume 1: Greenhouse Gas Emissions from the U.S. Power Sector*. Washington, DC: Office of Energy Policy and System Analysis.
- EIA. (2018, May 7). *Coal Markets*. Retrieved from Coal: <https://www.eia.gov/coal/markets/>
- EIA. (2018, May 7). *Henry Hub Natural Gas Spot Price*. Retrieved from Natural Gas: <https://www.eia.gov/dnav/ng/hist/rngwhhdd.htm>
- EPA. (2014, April 4). *Emission Factors for Greenhouse Gas Inventories*. Retrieved from Emission Factors: https://www.epa.gov/sites/production/files/2015-07/documents/emission-factors_2014.pdf
- European Commission. (2017, October 30). *Emissions Data and Maps*. Retrieved from European Database for Global Atmospheric Research: <http://edgar.jrc.ec.europa.eu/>
- European Commission. (2018, May 10). *CEMCAP: CO₂ capture from cement production*. Retrieved from Innovation and Networks Executive Agency: <https://ec.europa.eu/inea/en/horizon-2020/projects/h2020-energy/carbon-capture-and-storage/cemcap>
- Fischedick, M., Roy, J., Abdel-Aziz, A., Acquaye, A., Allwood, J., Ceron, J.-P., . . . Tanaka, K. (2014). Industry. In I. P. Change, *Climate Change 2014: Mitigation of Climate Change, Contribution of Working Group III to the Fifth Assessment Report of the Intergovernmental Panel on Climate Change* (pp. 739-810). Cambridge, UK and New York, NY, USA: Cambridge University Press.
- Global CCS Institute. (2017, August 29). *CEMCAP*. Retrieved from Projects Database: <https://www.globalccsinstitute.com/projects/cemcap>
- Global CCS Institute. (2017, October 10). *CO₂ Capture Test Facility at Norcem Brevik*. Retrieved from Projects Database: <https://www.globalccsinstitute.com/projects/co2-capture-test-facility-norcem-brevik>
- Global CCS Institute. (2017, August 29). *LEILAC*. Retrieved from Projects Database: <https://www.globalccsinstitute.com/projects/leilac>

- Global CCS Institute. (2018, March 13). *ITRI Calcium Looping Pilot*. Retrieved from Projects Database: <https://www.globalccsinstitute.com/projects/itri-calcium-looping-pilot>
- Hegerland, G., Pande, J. O., Haugen, H. A., Eldrup, N., Tokheim, L.-A., & Hatlevik, L.-M. (2006). Capture of CO₂ from a cement plant – technical possibilities and economical estimates. *International Conference on Greenhouse Gas Technologies* (pp. 1-5). Trondheim: GHGT.
- Hendriks, C. A., Worrell, E., de Jager, D., Blok, K., & Riemer, P. (2004). Emission Reduction of Greenhouse Gases from the Cement Industry. *Greenhouse Gas Control Technologies*. Cheltenham, UK: IEAGHG R&D Program.
- IEA. (2006, December). *CO₂ Capture & Storage*. Retrieved from IEA Energy Technology Essentials: <https://www.iea.org/publications/freepublications/publication/essentials1.pdf>
- IEA. (2009). *Energy Technology Transitions for Industry*. Paris: OECD/IEA. Retrieved from <https://www.iea.org/publications/freepublications/publication/industry2009.pdf>
- IEA. (2013). *Technology Roadmap: Carbon Capture and Storage*. Paris: Energy Technology Perspectives.
- IEA. (2015). *IEA CO₂ Emissions from Fuel Combustion Statistics*. Retrieved May 8, 2018, from OECD iLibrary: https://www.oecd-ilibrary.org/energy/data/iea-co2-emissions-from-fuel-combustion-statistics_co2-data-en
- IEAGHG. (2008). *CO₂ Capture in the Cement Industry*. Brighton: IEA.
- IEAGHG. (2013). *Deployment of CCS in the Cement Industry*. Cheltenham: IEA Environmental Projects. Retrieved from http://ieaghg.org/docs/General_Docs/Reports/2013-19.pdf
- IEAGHG. (2017). *What is CCS?* Retrieved from CCS Resources: <http://ieaghg.org/ccs-resources/what-is-ccs>
- Industrial Technology Research Institute. (2017, February). *Calcium-Looping CO₂ Capture Technology*. Retrieved from Green Energy and Environment Research Laboratory: <https://www.itri.org.tw/eng/Content/MSGPic01/contents.aspx?&SiteID=1&MmmID=620170236661141772&CatID=620170237111073501&MSID=620170263150637304>
- LEILAC. (2018, February 17). *The core technology - Direct Separation*. Retrieved from Low Emissions Intensity Lime & Cement: <https://www.project-leilac.eu/>
- Moore, D. (2018a, February 23). *Wet and Semi-Wet Process Kilns*. Retrieved May 8, 2018, from Cement Kilns: http://www.cementkilns.co.uk/long_wet_kilns.html
- Moore, D. (2018b, February 14). *Suspension preheater kilns*. Retrieved from Cement Kilns: http://www.cementkilns.co.uk/suspension_preheater_kilns.html
- NETL. (2014). *Cost of Capturing CO₂ from Industrial Sources*. Pittsburgh: DOE.
- NETL. (2018). *Post Combustion CO₂ Capture*. Retrieved from Carbon Capture: <https://www.netl.doe.gov/research/coal/carbon-capture/post-combustion>

- PBL Netherlands Environmental Assessment Agency. (2017). *Trends in Global CO2 and Total Greenhouse Gas Emissions*. PBL Netherlands Environmental Assessment Agency. Retrieved from <http://www.pbl.nl/en/publications/trends-in-global-co2-and-total-greenhouse-gas-emissions-2017-report>
- Portland Cement Association. (2002). *Design and Control of Concrete Mixtures*. Skokie, IL: Portland Cement Association. Retrieved from https://www.researchgate.net/profile/Steven_Kosmatka/publication/284663491_Design_and_Control_of_Concrete_Mixtures/links/5655d8f908aefe619b1c5f2b/Design-and-Control-of-Concrete-Mixtures.pdf
- Revill, J. (2017, December 12). Cement demand set to rise 1.5 pct in 2018 - World Cement Association. *Reuters*. Retrieved from <https://www.cnbc.com/2017/12/12/reuters-america-interview-cement-demand-set-to-rise-1-point-5-pct-in-2018--world-cement-association.html>
- Romano, M. C., Spinelli, M., Campanari, S., Consonni, S., Cinti, G., Marchi, M., & Borgarello, E. (2013). The Calcium Looping Process for Low CO2 Emission Cement and Power. *Energy Procedia*, 7091-7099.
- SES. (2018). *Cryogenic Carbon Capture*TM. Retrieved from SES Innovation: https://sesinnovation.com/technology/carbon_capture/
- Thomas, J., & Jennings, H. (2008, August 14). *Burning in a kiln – formation of cement clinker*. Retrieved from The Science of Concrete: http://www.iti.northwestern.edu/cement/monograph/Monograph3_4.html
- United Nations. (2017). *World Population Prospects 2017*. Retrieved from United Nations Population Division: <https://esa.un.org/unpd/wpp/DataQuery/>
- United States Geological Survey. (2018, April 30). *Minerals Yearbook*. Retrieved from Cement Statistics and Information: <https://minerals.usgs.gov/minerals/pubs/commodity/cement/>